

SM Series



Repair manual

INDEX

1. INTRODUCTION	3
2. REPAIR GUIDELINES	3
2.1 Repairing mechanical parts.....	3
2.1.1 Disassembly of mechanical parts.....	4
2.1.2 Assembly of mechanical parts	15
2.1.3 Increase and reduction classes	27
2.2 Repairing hydraulic parts.....	27
2.2.1 Dismantling the head – liner – valves.....	27
2.2.2 Assembling the head – liner – valves	31
2.2.3 Dismantling the piston unit – supports – seals.....	31
2.2.4 Assembling the piston unit – supports – seals	33
3. SCREW TIGHTENING CALIBRATION	37
4. REPAIR TOOLS	40
5. REPLACING THE CON-ROD FOOT BUSH	41

1. INTRODUCTION

This manual describes the instructions for repair of the SM pump family and should be carefully read and understood before any intervention on the pump.

Proper pump operation and duration depend on the correct use and maintenance.

Interpump Group disclaims any responsibility for damage caused by negligence or failure to observe with the standards described in this manual.

2. REPAIR GUIDELINES



2.1 Repairing mechanical parts

Mechanical parts repair must be performed after removal of oil from the casing.

To take out the oil, remove the oil dipstick pos.①, fig.1 and then the discharge plug pos.②, fig.1

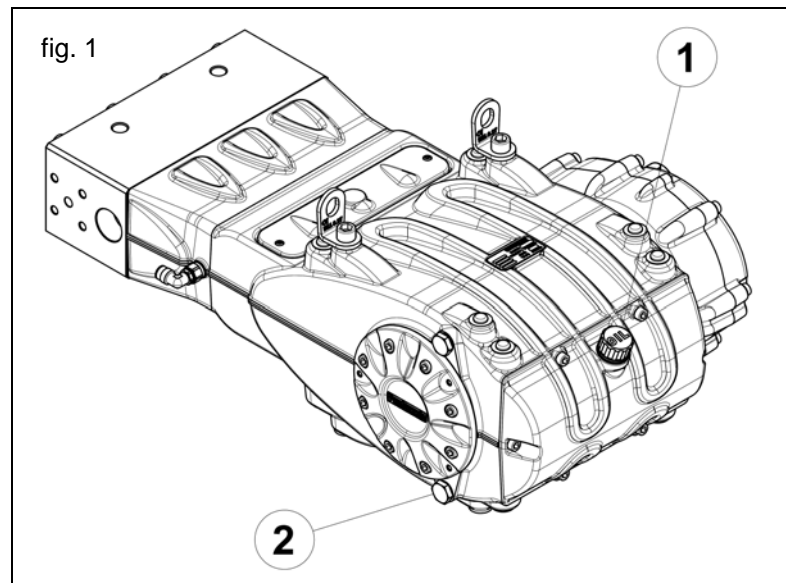

The oil must be placed in a suitable container and disposed of in special centres. It absolutely should not be discarded into the environment.

2.1.1 Disassembly of mechanical parts

The proper sequence is as follows:

Fully empty the oil from the pump, then disassemble the casing cover (and relative O-ring), unscrewing the 6 M10 screws (pos. ①, fig.2).

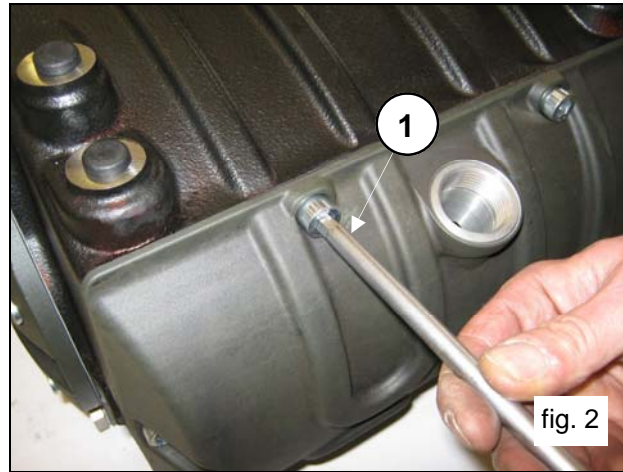

Remove the tab from the PTO shaft (pos. ①, fig.3).

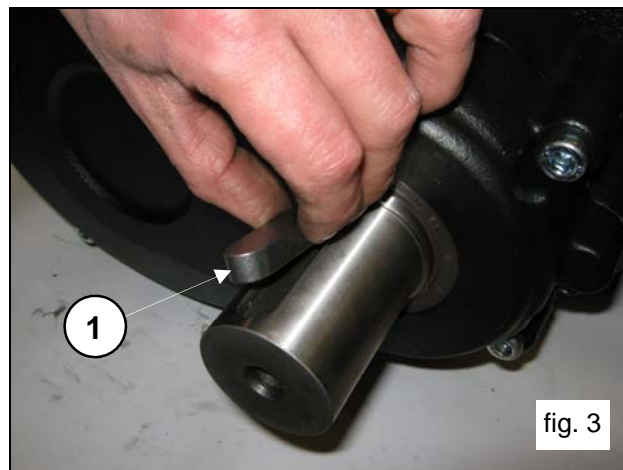

Unscrew the reduction gear cover fixing screws (pos. ①, fig.4).



Position the 3 grub screws or M8 threaded screws (pos.①, fig.5) with the function of extractors in the holes and two sufficiently long M10 screws with the function of supporting the cover (pos.②, fig.5).

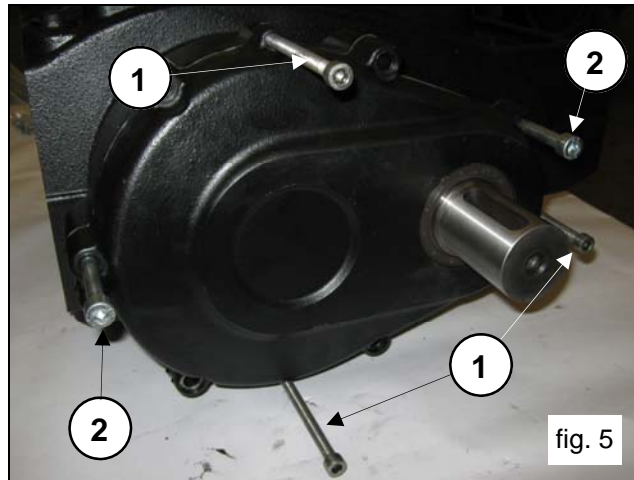

Slowly screw in the 3 M8 screws (pos.①, fig.6) with the function of extractors to fully remove the cover unit and pinion

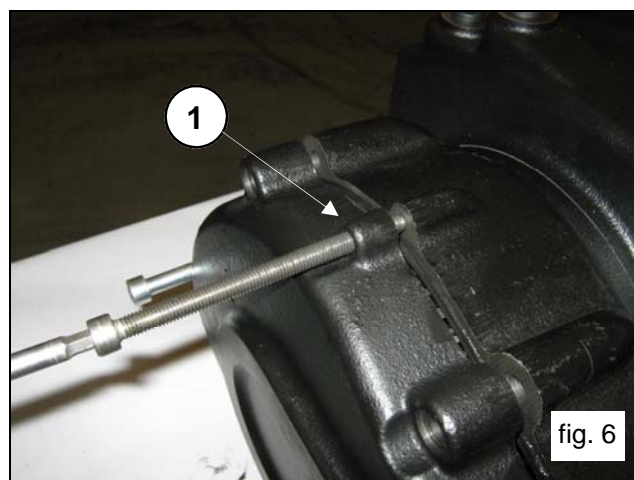

Complete disassembly of the reduction gear cover from the pinion is possible following these steps:
Remove the Seeger ring Ø120 (pos.①, fig.7)

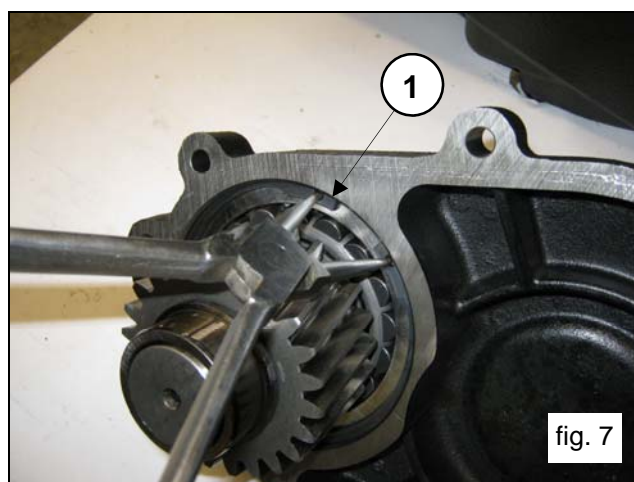

Separate the pinion from the cover, working with an extractor hammer on the pinion itself (pos.①, fig.8)

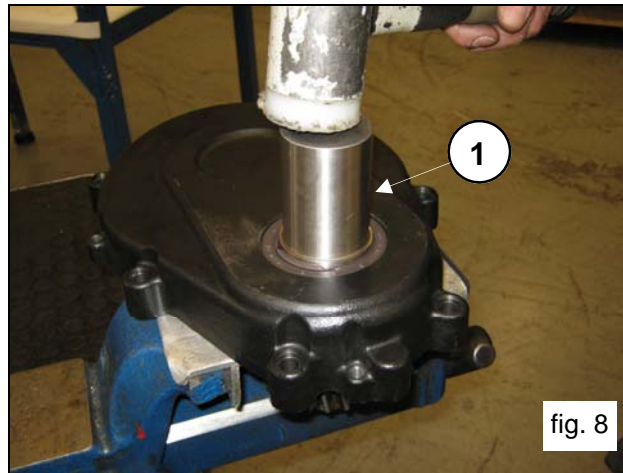

Remove the Seeger ring Ø55 (pos.①, fig.9) and the bearing support ring (pos.①, fig.10) from the pinion

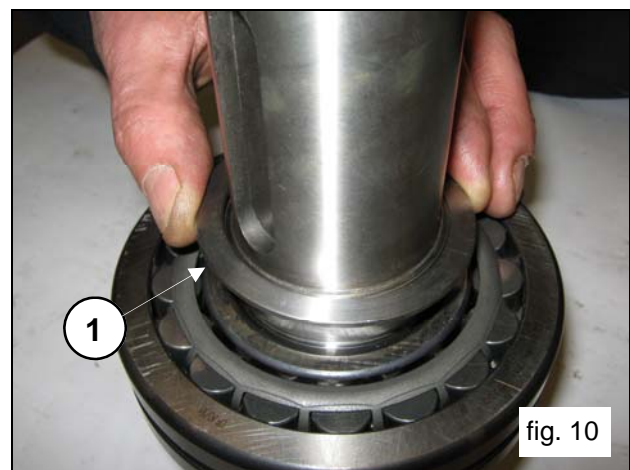
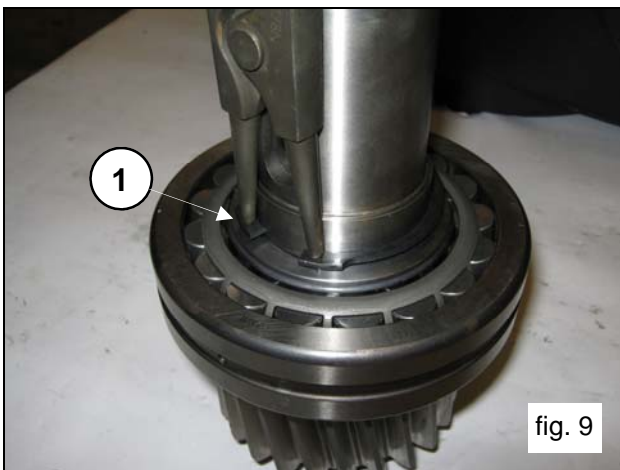

Extract the seal ring from the reduction gear cover, working from the inner side of the cover (pos.①, fig.11).

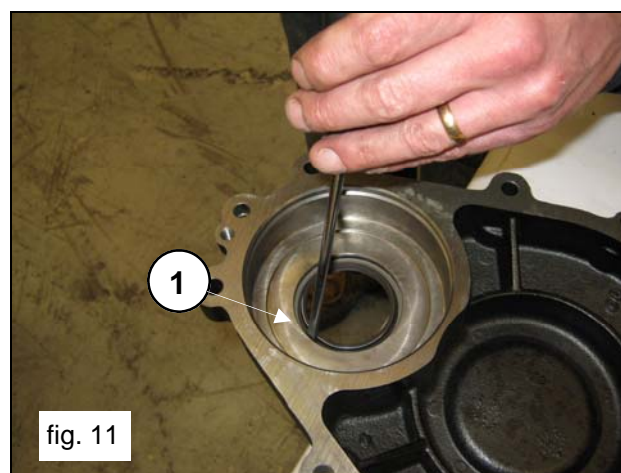

Unscrew the screws holding in the ring gear (pos.①, fig.12) and remove it (pos.①, fig.13).

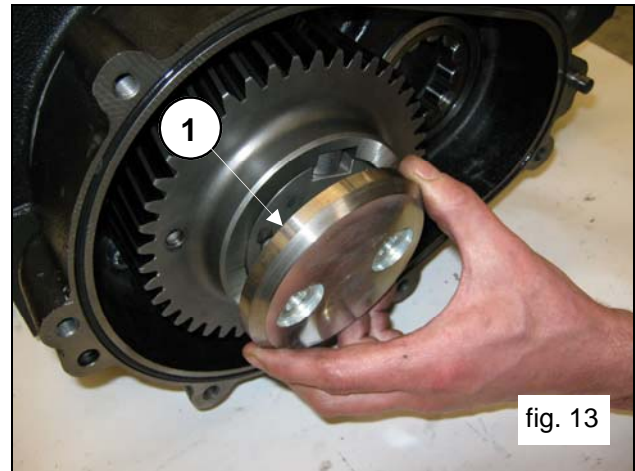
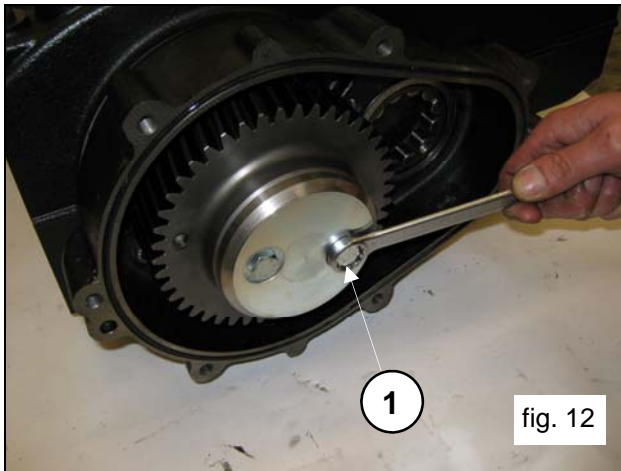

Remove the ring gear (pos.①, fig.14). Where necessary, it is possible to utilise an extractor hammer to be applied on the 2 M8 holes (pos.②, fig.14).

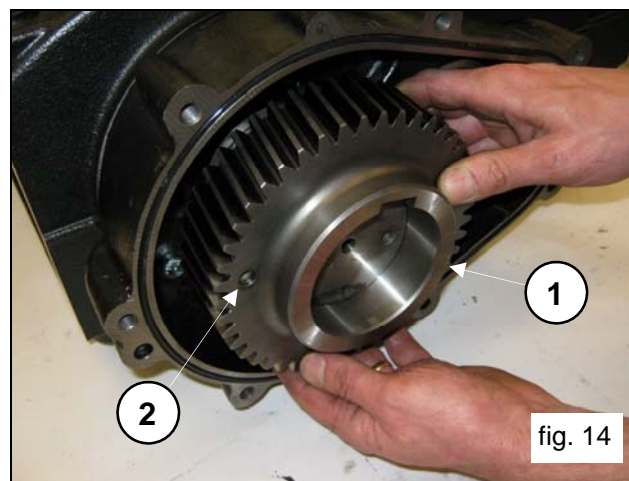

Remove the tab from the shaft (pos.①, fig.15).

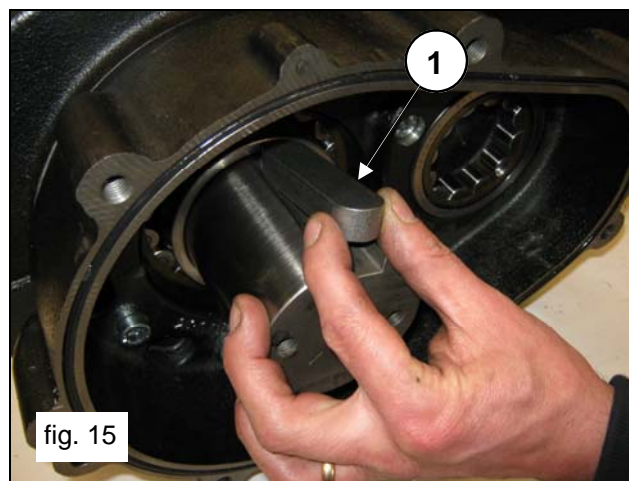

Remove the ring gear support ring (pos. ①, fig.16).



Unscrew the con-rod screws (pos. ①, fig.17).



Remove the con-rod caps with the lower semi-bearings, taking special care of the disassembly sequence during disassembly.



The con-rod caps and their relative half supports must be reassembled in exactly the same order and coupling with which they were disassembled.

To avoid possible errors, caps and half supports have been numbered on one side (pos. ①, fig.18).

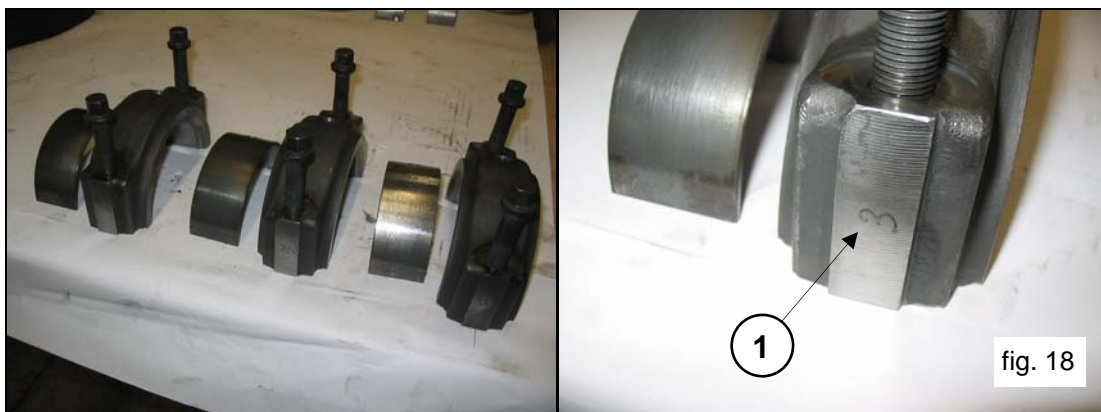

Advance the half supports completely in the direction of the hydraulic part to allow the bend shaft to come out. To facilitate this operation, use special tool (code 27566200), (pos.①, fig.19).

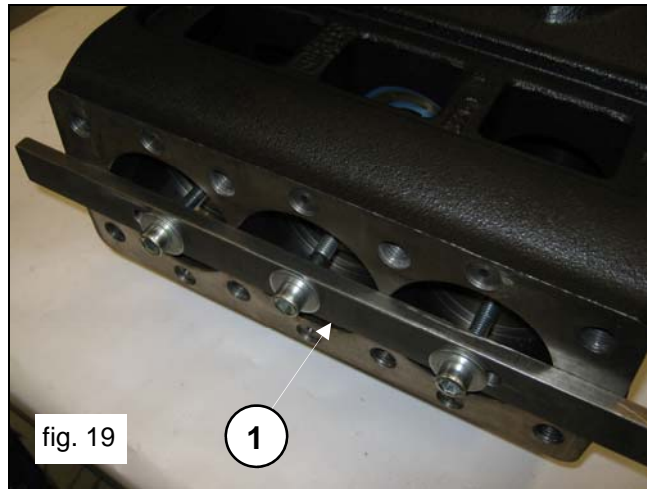

Remove the three upper half-bearings of the half supports (pos.①, fig.20).

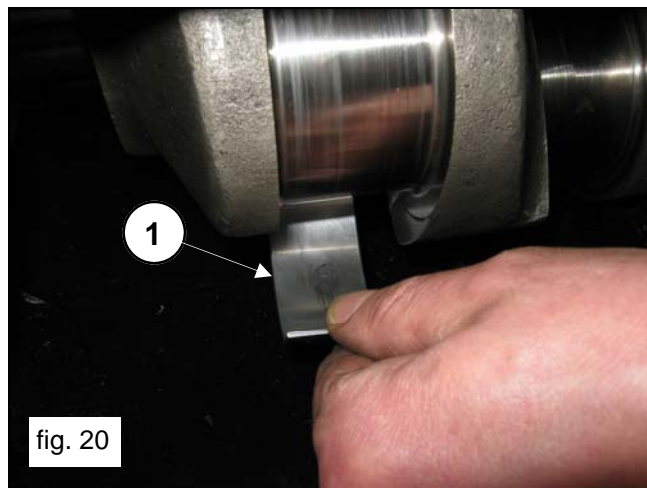

Unscrew the reduction gear box fixing screws (pos.①, fig.21 e fig.22).

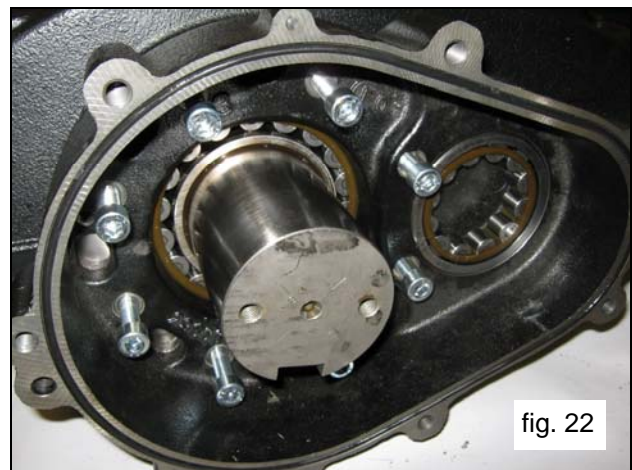
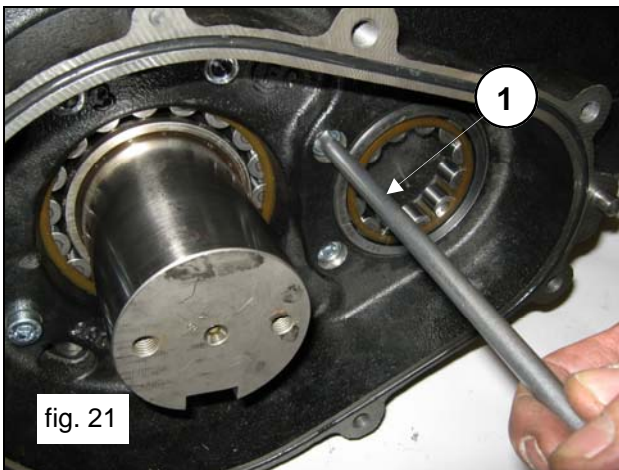

Position the 3 grub screws or M8 threaded screws (pos.①, fig.23) with the function of extractors in the holes and two sufficiently long M10 screws with the function of supporting the reduction gear box (pos.②, fig.23).

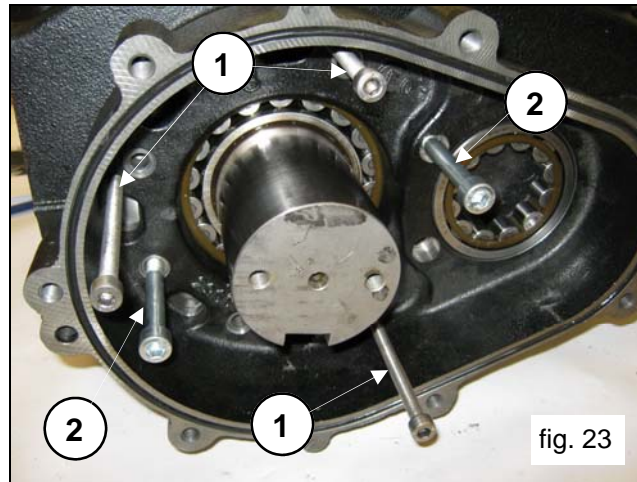

Slowly screw in the 3 M8 screws (pos.①, fig.24) to prevent that the box can tilt too far and get locked in the housing.

Remove the box while supporting the shaft to prevent damage (pos.①, fig.25).

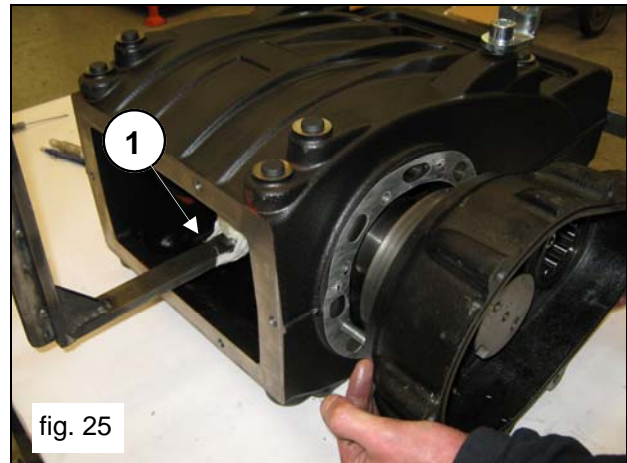
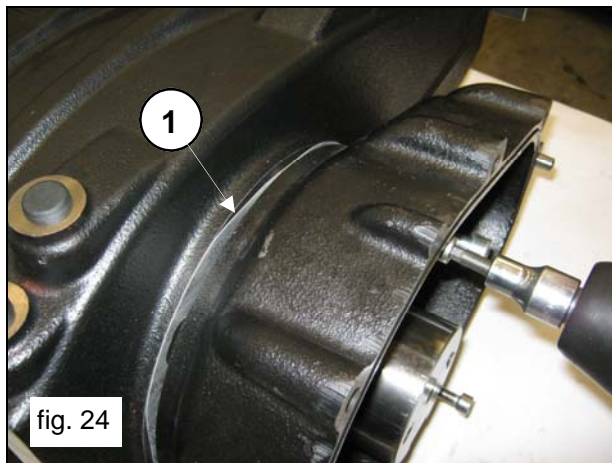

Unscrew the bearing cover fixing screws from the opposite side (pos.①, fig.26 and fig.27).

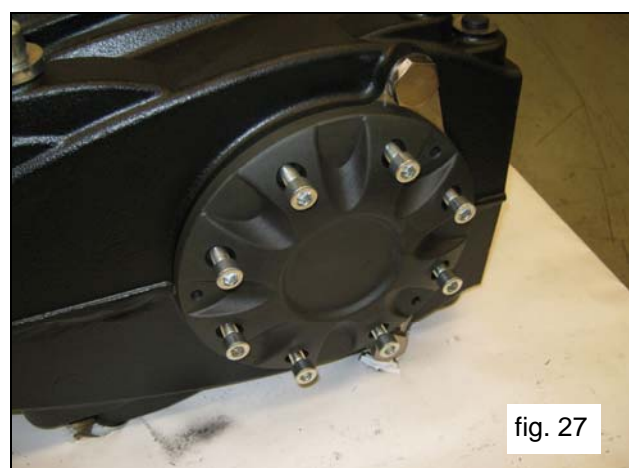
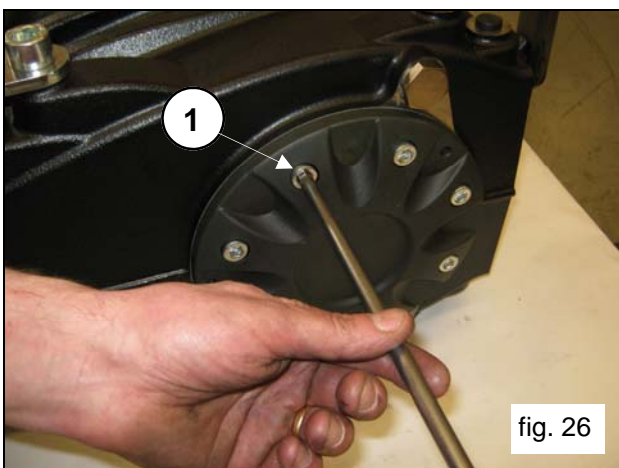

Position the 3 grub screws or M8 threaded screws (pos. ①, fig.28) with the function of extractors in the holes

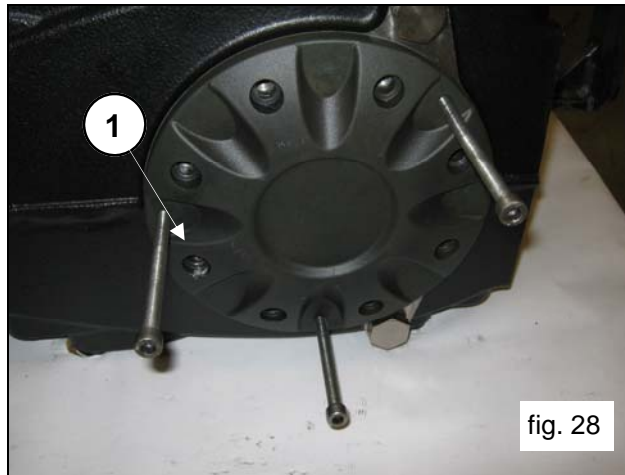

Slowly screw in the 3 M8 screws (pos. ①, fig.29) to prevent that the cover can tilt too far and get locked in the housing.

Remove the bearing cover while supporting the shaft to prevent damage (pos. ①, fig.30).

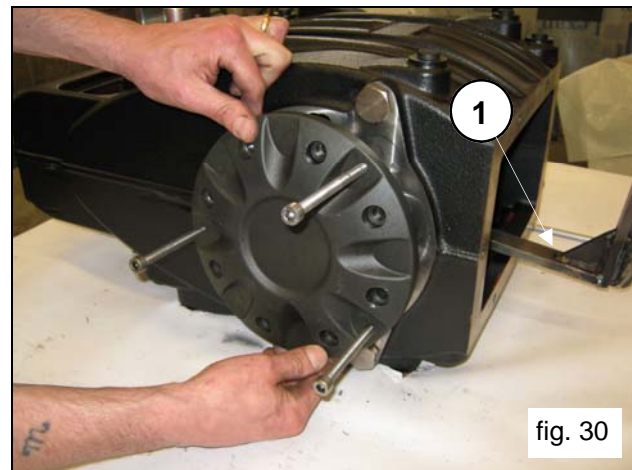
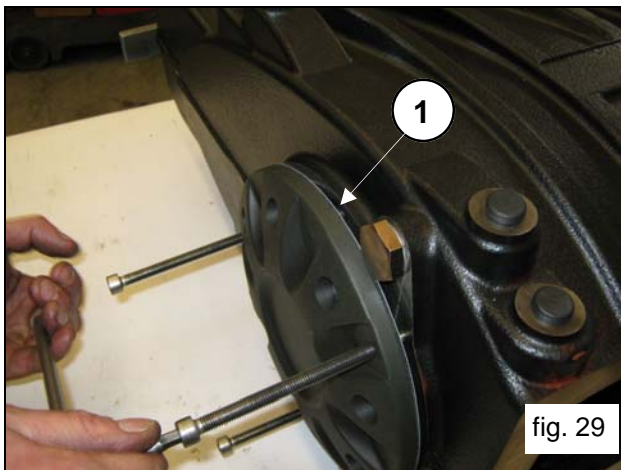

Remove the bend shaft casing from the PTO side (pos. ①, fig.31).

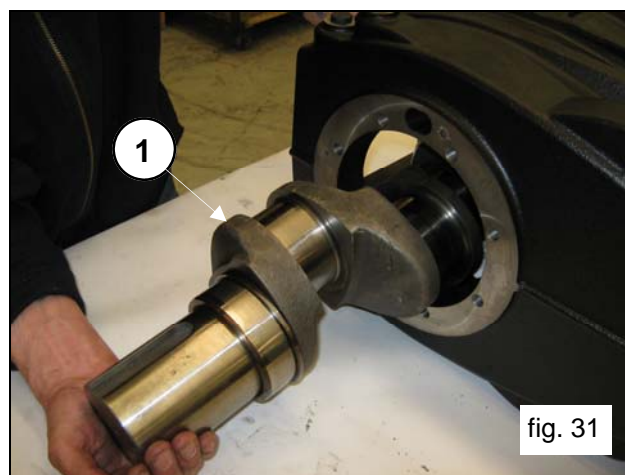

In the event that it is necessary to replace one or more con-rods or piston guides, operate as follows: Unscrew the screws with tool code 27566200 to unlock the con-rods (pos.①, fig.32) and then extract the con-rod-piston guide units from the back casing opening (pos.①, fig.33).

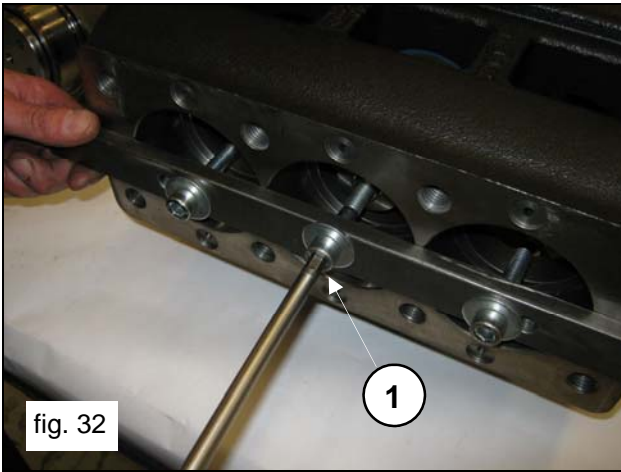

It is now possible to disassemble the piston guide seal rings, taking care to not damage the piston guide sliding rod.



Whenever it becomes necessary to replace the piston guide seal rings without dismantling the entire mechanical part, it is possible to extract the seal rings with the use of tool code 27918500 operating as follows:

Insert the tool between the rod and the seal ring (pos.①, fig.34) and, with the extractor hammer, complete insertion of the tapered section inside the seal ring (pos.①, fig.35)

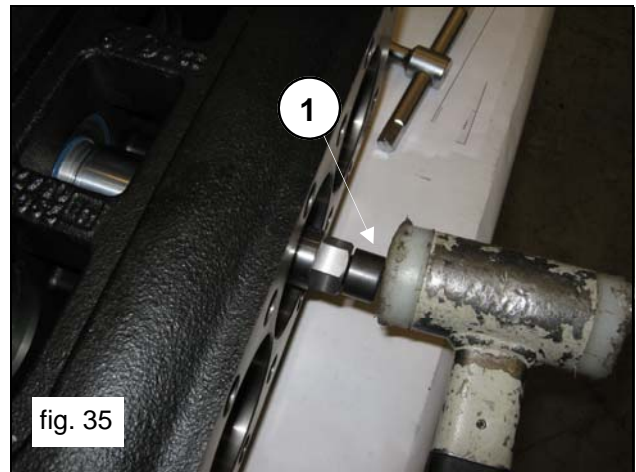

Extract the seal ring using the tool extractor hammer (pos. ①, fig.36)

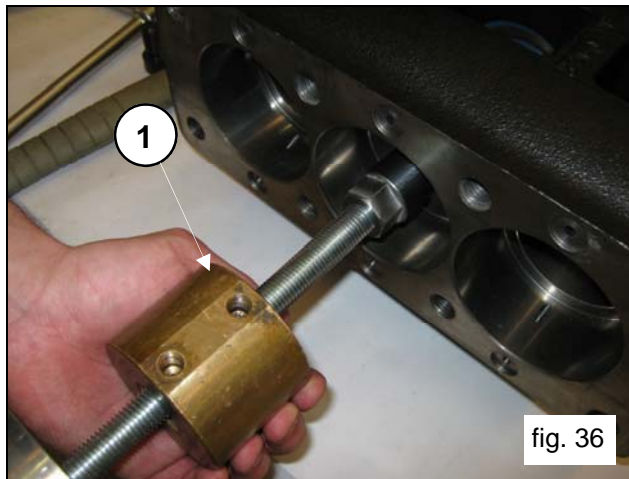

Remove the two spindle locking Seeger rings Ø120 (pos. ①, fig.37).



Remove the spindle (pos. ①, fig.38) and extract the con-rod (pos. ①, fig.39)



Couple the half supports to the previously disassembled caps, referring to the numbering (pos. ①, fig.40).



To separate the rod from the piston guide, unscrew the hexagonal head M10 screws with a 17 socket wrench (pos. ①, fig.41), blocking the rod with the 36 fork spanner.

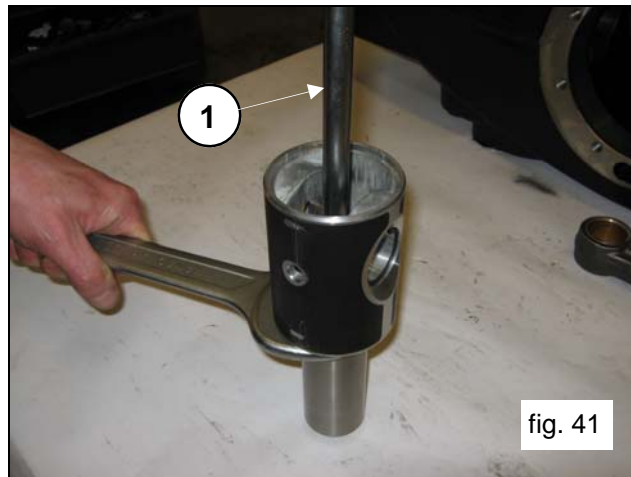

2.1.2 Assembly of mechanical parts

Proceed with assembly following the reverse order indicated in point 2.1.1.
The proper sequence is as follows:

Assemble the rod to the piston guide.

Insert the elastic pin Ø5 in its hole on the piston guide (pos.①, fig.42) and join the rod to the piston guide by means of M10x35 screws (pos.①, fig.43).

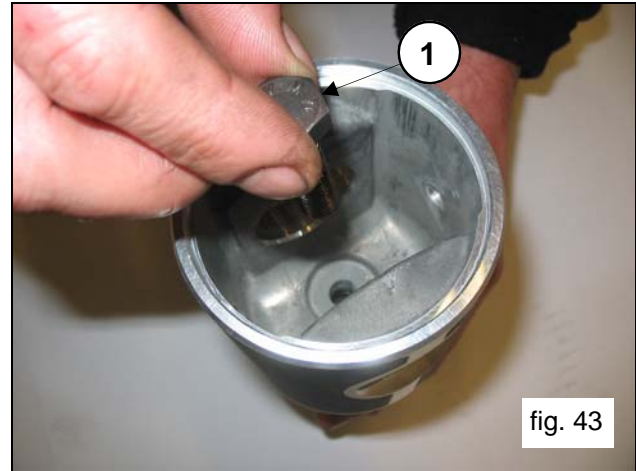
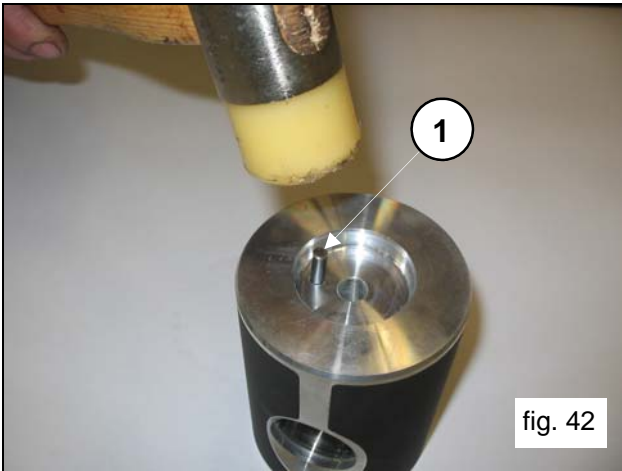

Lock in the rod in correspondence with the two planes with a 36 fork spanner (pos.①, fig.44) and proceed with calibration with a torque wrench (pos.①, fig.45) as indicated in paragraph 3 “Screw tightening calibration”.

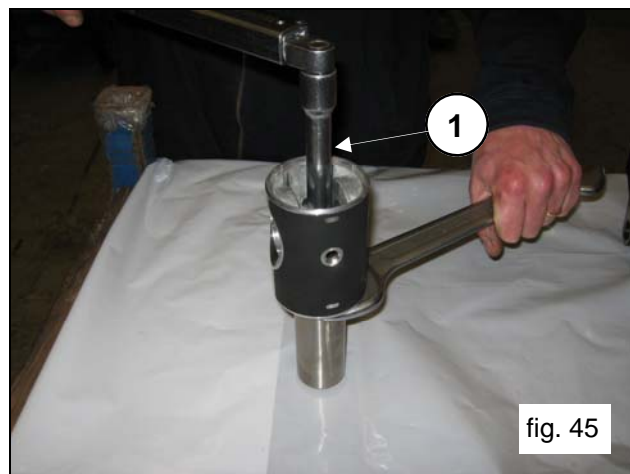
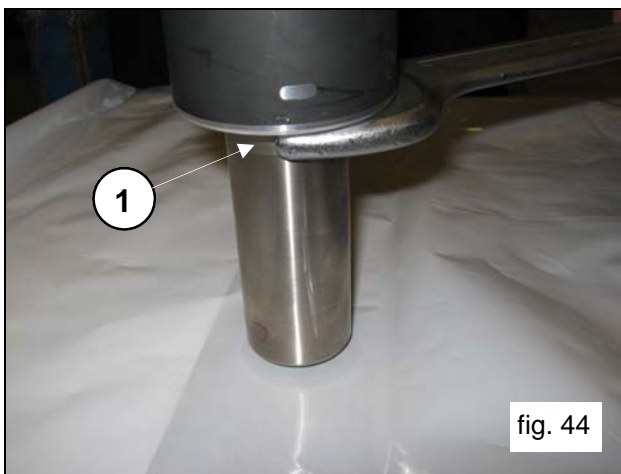

Insert the con-rod in the piston guide (pos.①, fig.39) and then insert the spindle (pos.①, fig.38). Apply the two shoulder Seeger rings (pos.①, fig.37).



Assembly has been carried out properly if the con-rod foot, piston guide and spindle rotate freely

Separate the caps from the half supports. Proper coupling can be verified by the numbering on the side (pos.①, fig.40).

After having checked casing cleaning, proceed with assembly of half support-piston guide unit inside casing rods (pos.①, fig.33).



Insertion of the half support-piston guide unit in the casing must be made with the half bearings set in the direction in which numbers are visible from above

Block the three units with the use of special tool code 27566200 (pos.①, fig.32).

Pre-assemble the ring inside the bend shaft bearings (on both sides of the shaft down to the stroke) using special tool code 27604700 (pos.①, fig.46) (pos.①, fig.47).



The inner and outer rings of the bearings must be reassembled keeping the same coupling with which they were disassembled

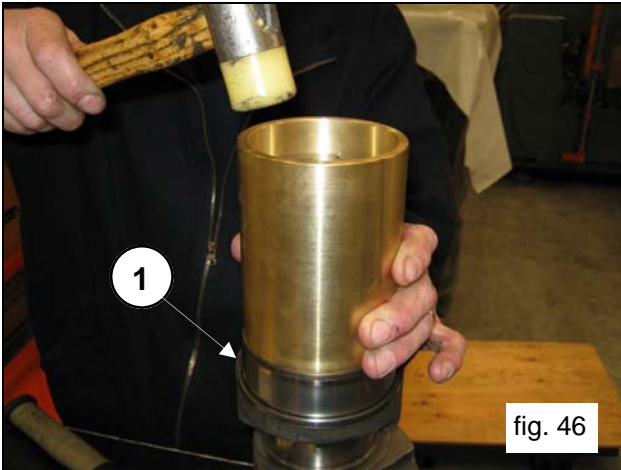

Insert the shaft from the PTO side, taking care not to hit the previously assembled con-rod shanks (pos.①, fig.48) and (pos.①, fig.49).

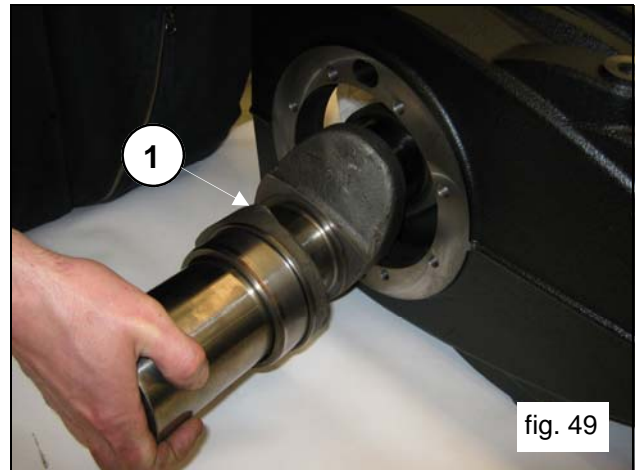
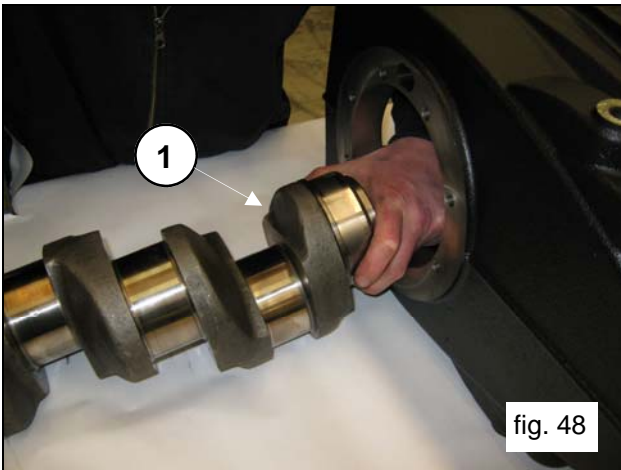

The bend shaft must always be assembled with the PTO on the opposite side with respect to the G1/2" holes for the oil discharge plugs on the pump casing (pos.②, fig.51).

Fully insert the shaft in the casing (pos.①, fig.50 and fig.51)

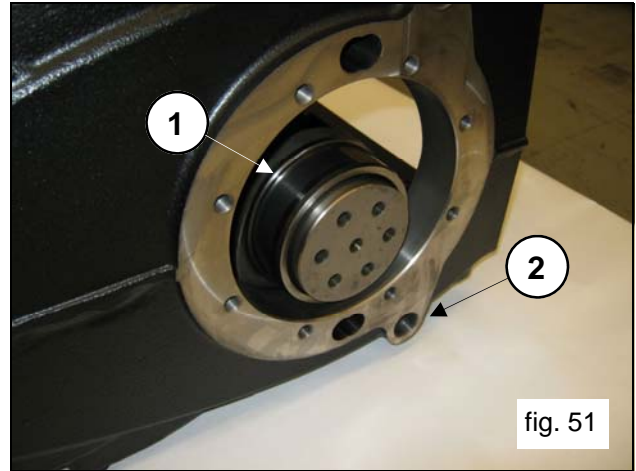
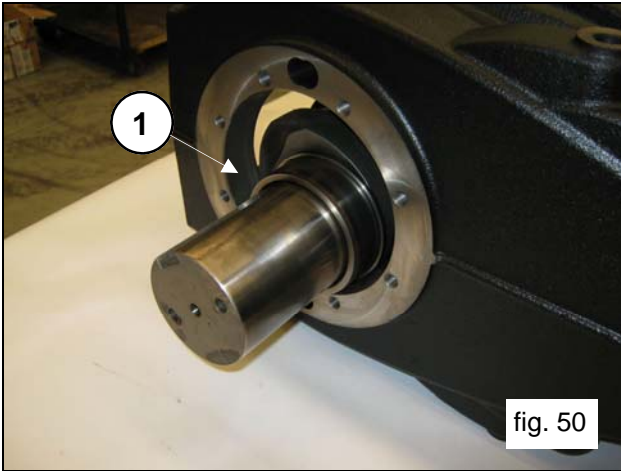

Pre-assemble the outer ring of the pinion bearing on the reduction gear with the aid of special tool code 27604900 (pos.①, fig.52), inserting fully down to end stroke (pos.①, fig.53)

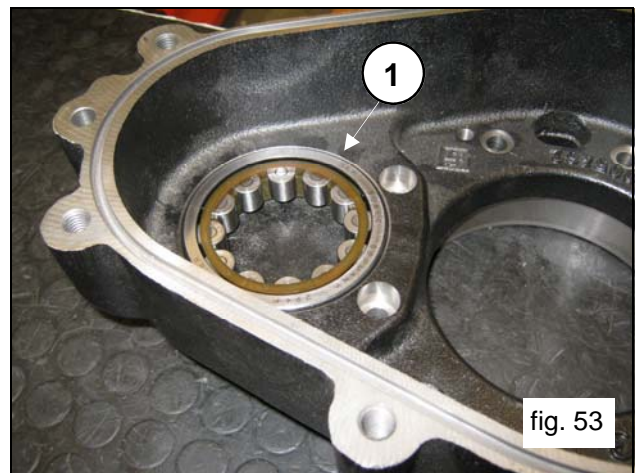
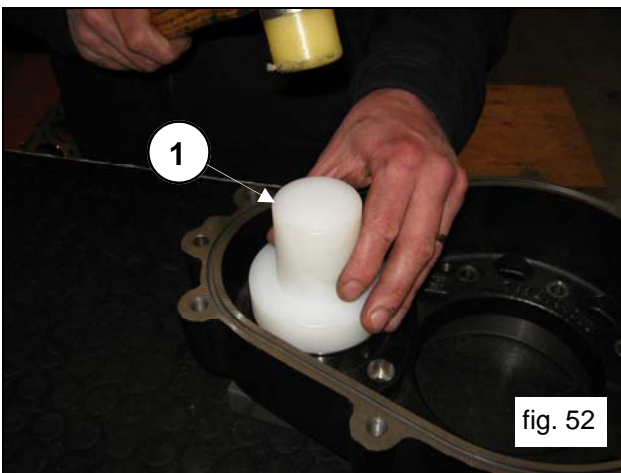

From the opposite side of the reduction gear box, pre-assemble the external ring of the bend shaft bearing with the use tool code 27605000 (pos.①, fig.54), inserting fully down to end stroke (pos.①, fig.55)

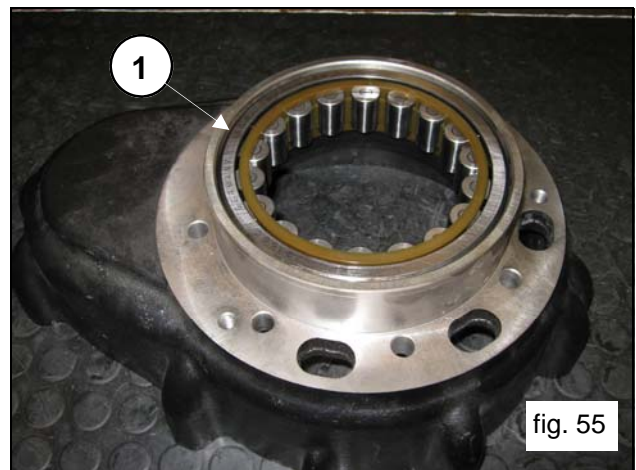
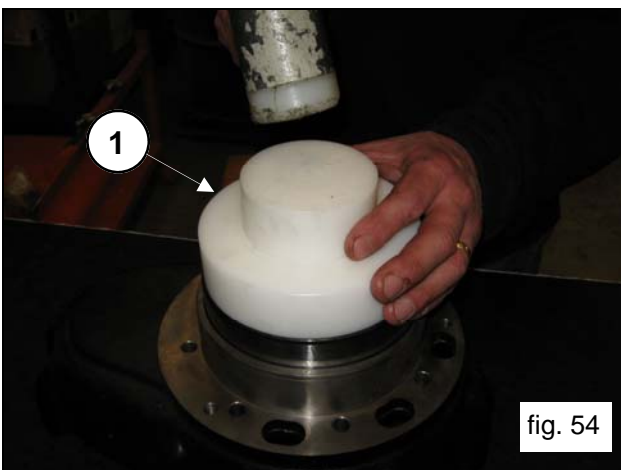

Repeat this operation on the bearing box, pre-assembling the external bend shaft bearing ring with the help of special tool code 27605000 (pos. ①, fig.56), inserting fully down to end stroke (pos. ①, fig.57)

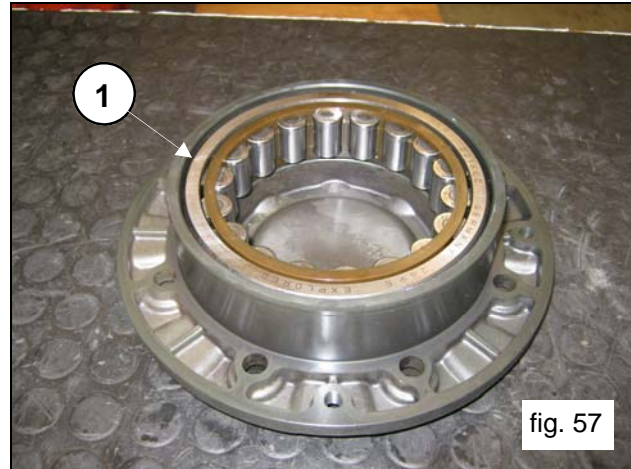
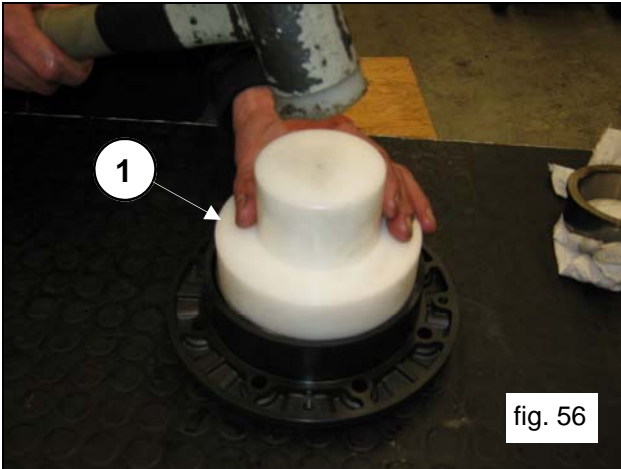

Insert the side seal on the bearing cover (pos. ①, fig.58) and lift the bend shaft to favour cover insertion (pos. ①, fig.59).

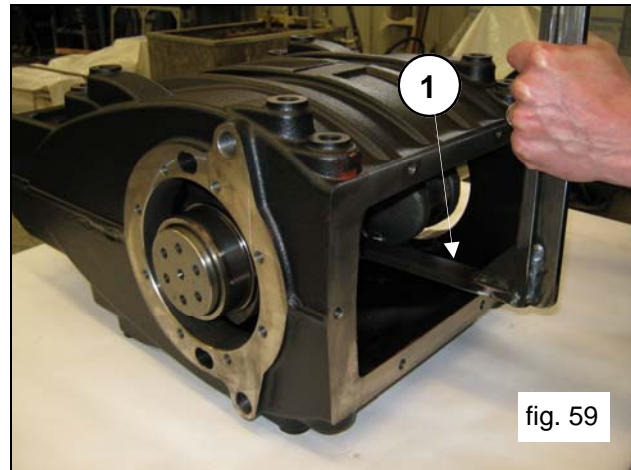
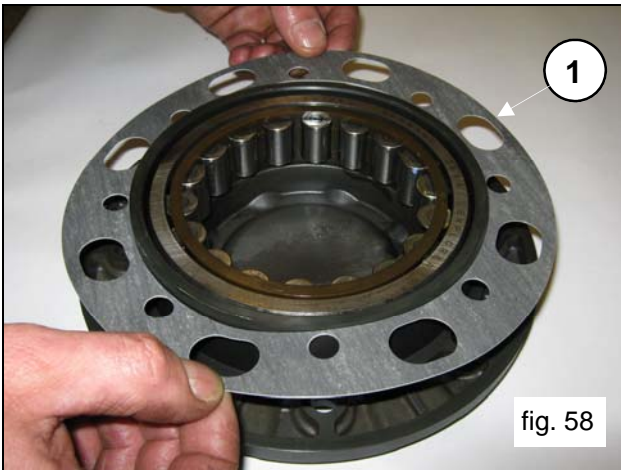

Assemble the bearing cover (and relative seal) using an extractor hammer (pos. ①, fig.60)



Position the bearing cover in such a way that the "Pratissoli" logo is perfectly horizontal

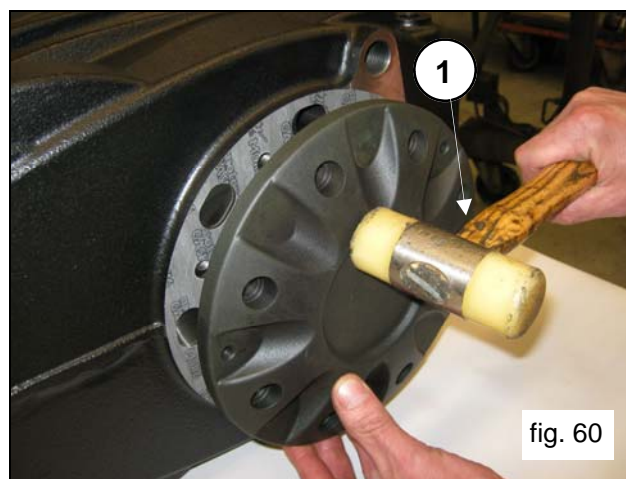

Tighten the 8 M10x30 screws (pos.①, fig.61).

Calibrate the screws with a torque wrench as indicated in paragraph 3 "Screw tightening calibration".

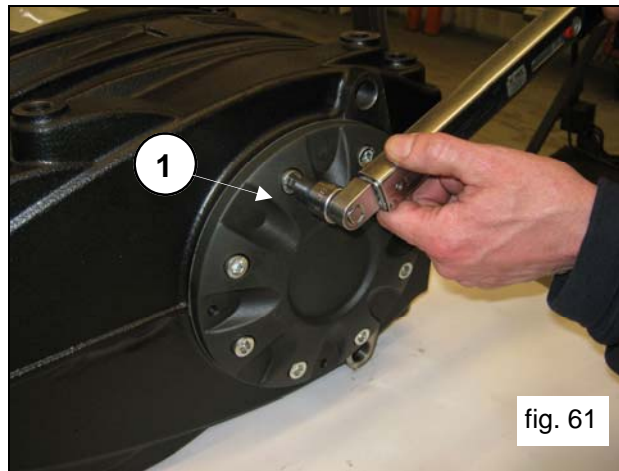

From the opposite side, insert the side seal on the reduction gear box (pos.①, fig.62) and lift the bend shaft to favour cover insertion (pos.①, fig.63).

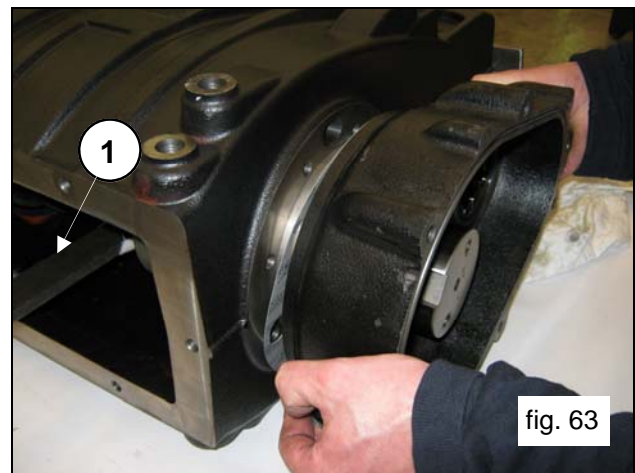
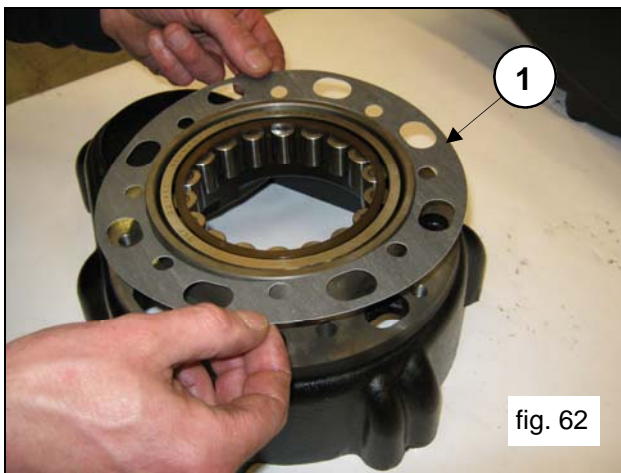

Assemble the reduction gear box (and relative seal) using an extractor hammer (pos.①, fig.64)

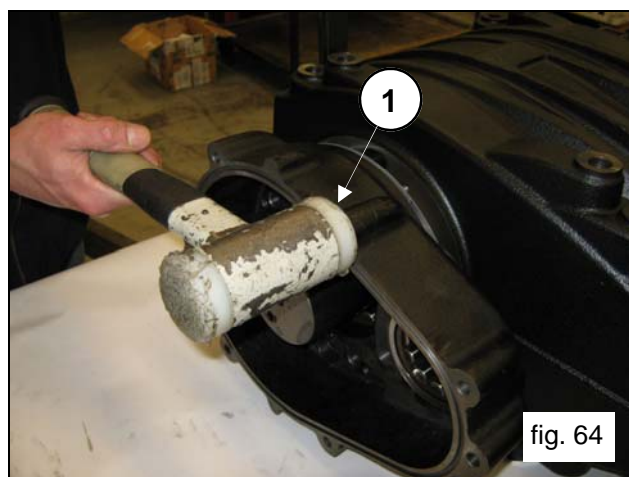

Tighten the 8 M10x40 screws (pos.①, fig.65).

Calibrate the screws with a torque wrench as indicated in paragraph 3 "Screw tightening calibration".

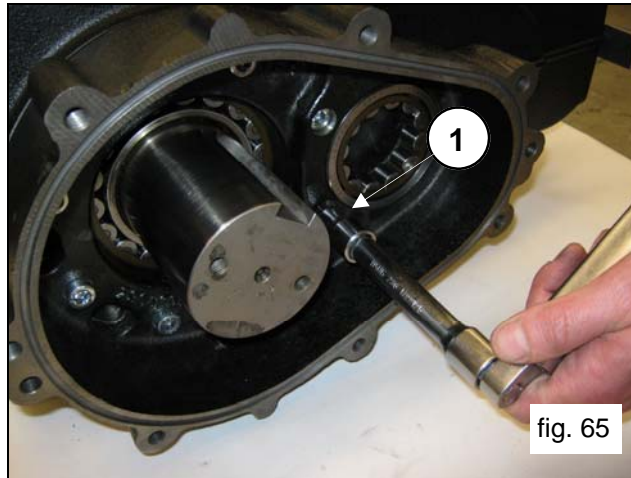

fig. 65

Remove the tool for blocking the con-rods code 27566200 (pos.①, fig.32).

Insert the upper half-bearings between the con-rods and the shaft (pos.①, fig.66).



For proper assembly of the half-bearings, ensure that the reference tab on the half-bearings are positioned in their housing on the half support (pos.①,fig.67).

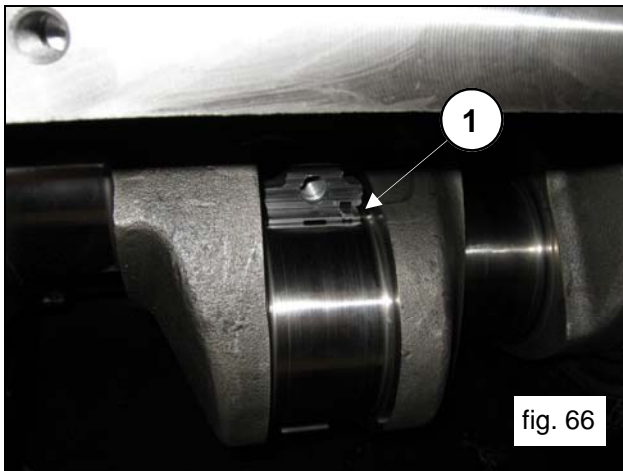

fig. 66

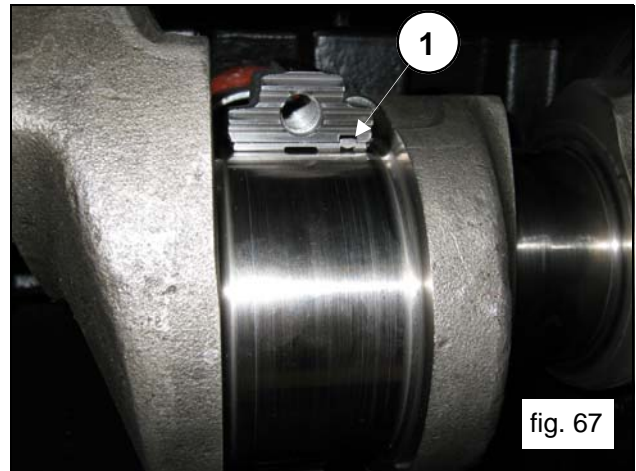

fig. 67

Apply the lower half-bearings to the caps (pos.①, fig.68) ensuring that the half-bearing reference notches are positioned in their housing on the cap (pos.②, fig.68).

Fasten the caps to the half supports by means of M10x1.5x80 screws (pos.①, fig.69).



Note the correct assembly direction of the caps. Numbering must be turned upward.

Calibrate the screws with a torque wrench as indicated in paragraph 3 "Screw tightening calibration", bringing the screws to tightening torque at the same time.

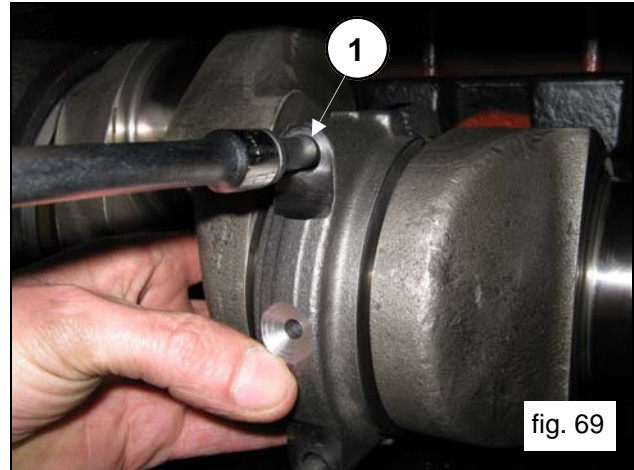
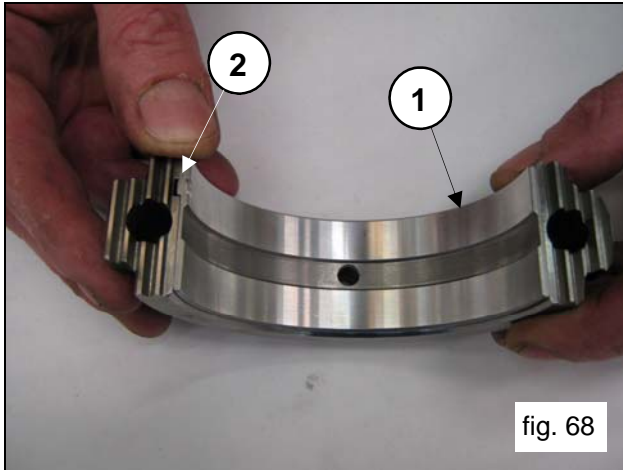

After finishing this operation, verify that the con-rods have axial clearance in both directions.

Insert the piston guide seal rings in their casing housing by means of a special tool code 27605300. Position the component on the rod (pos. ①, fig.70a) and strike on the tool until the seal ring is fully inserted in the housing (pos. ①, fig.70b)

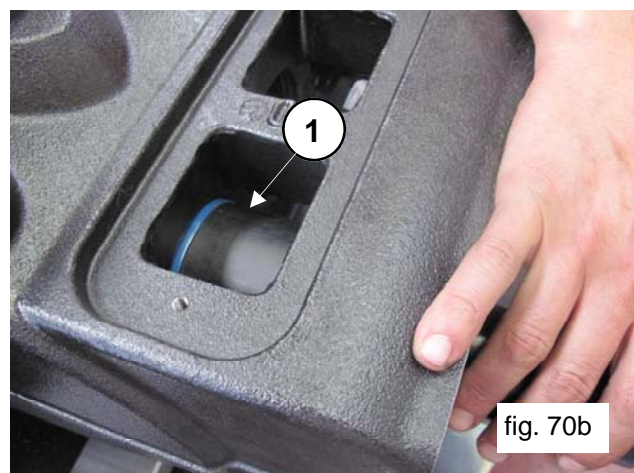
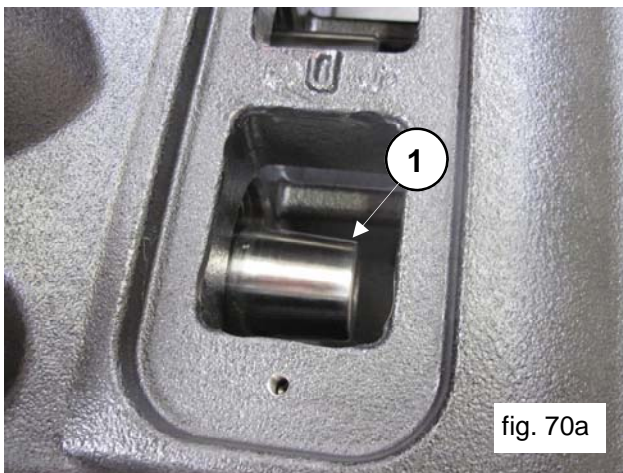

Insert the O-ring on the rear cover (pos. ①, fig.71) and assemble the cover on the casing with the aid of 6 M10x30 screws (pos. ①, fig.72).

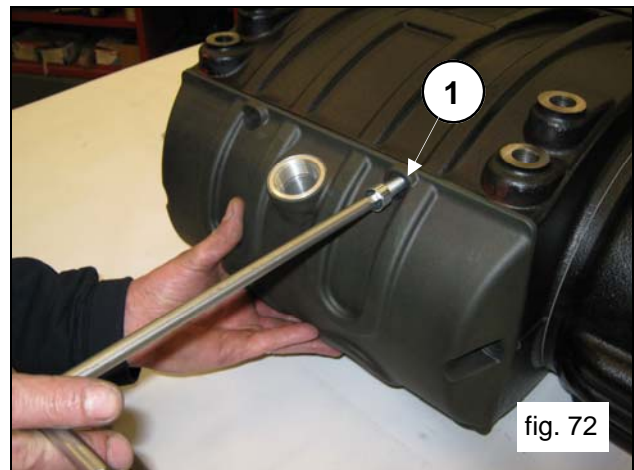
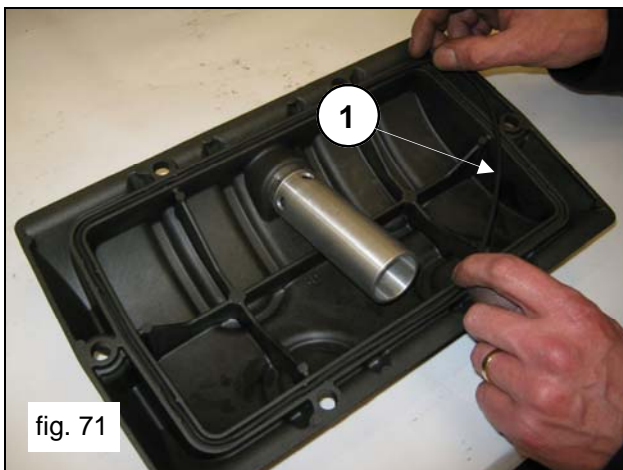



Take care to fully and properly insert the O-ring in its housing on the cover to prevent these can become damaged during screw tightening

Calibrate the screws with a torque wrench as indicated in paragraph 3 "Screw tightening calibration".

Insert the ring gear support ring in the bend shaft shank (pos. ①, fig.73) to end stroke (pos. ①, fig.74)

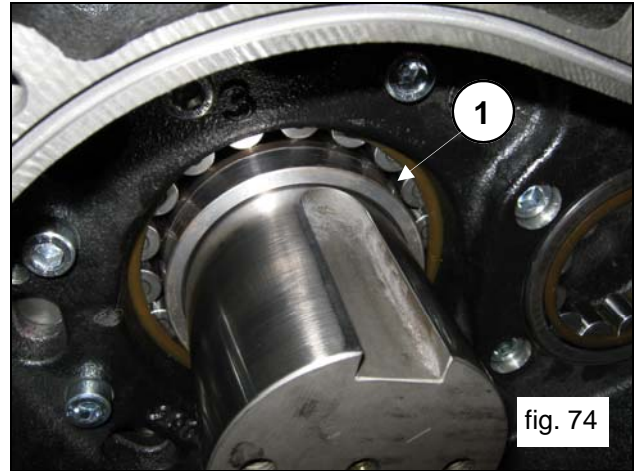
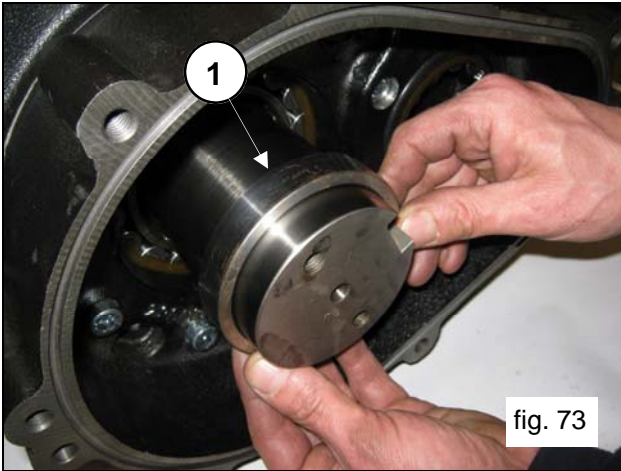

Apply tab 22x14x80 in the shaft housing (pos. ①, fig.75) and insert the ring gear on the shaft (pos. ①, fig.76).



The ring gear must be assembled making sure that the two M8 holes (to be used for extraction) be turned outward of the pump (pos. ②, fig.76).

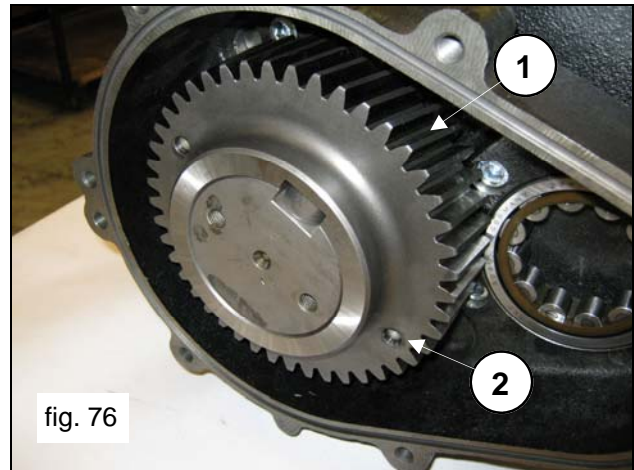
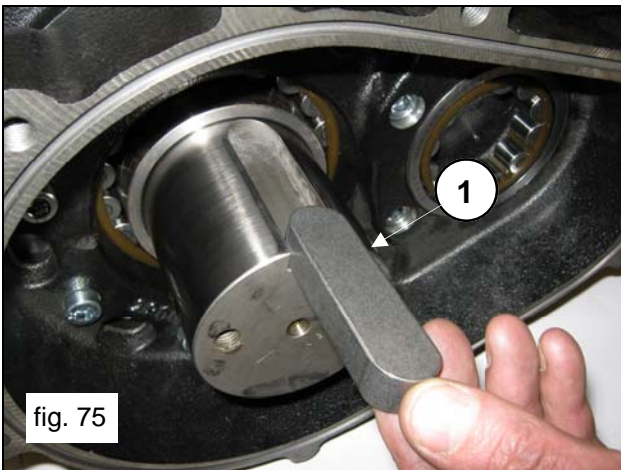

Fasten the ring gear stop (pos.①, fig.77) using 2 M10x25 screws.
 Calibrate the screws with a torque wrench as indicated in paragraph 3 "Screw tightening calibration" (pos.①, fig.78).

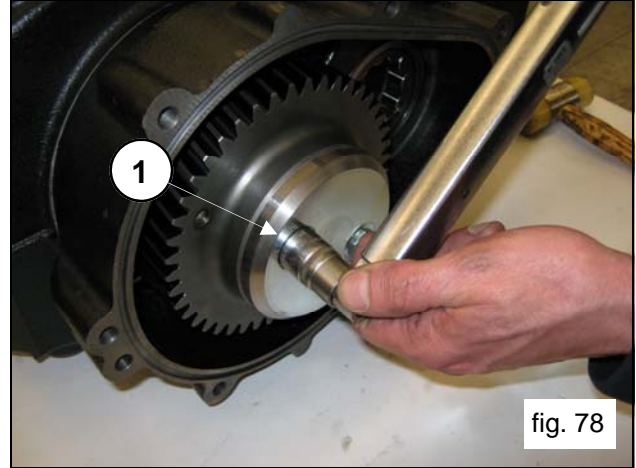
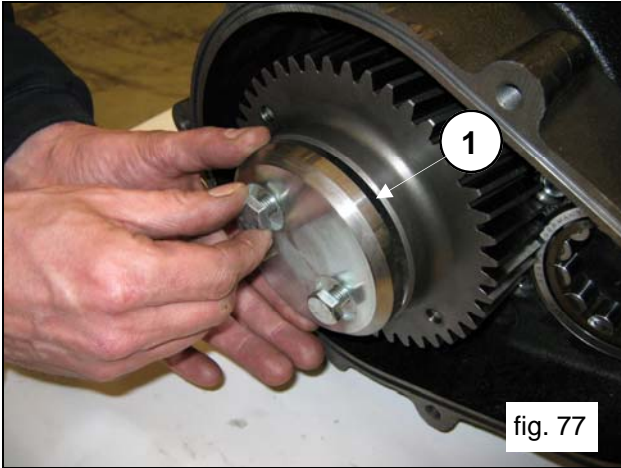

Apply the two Ø10x24 pins on the reduction gear box (pos.①, fig.79) and insert the O-ring (pos.①, fig.80).

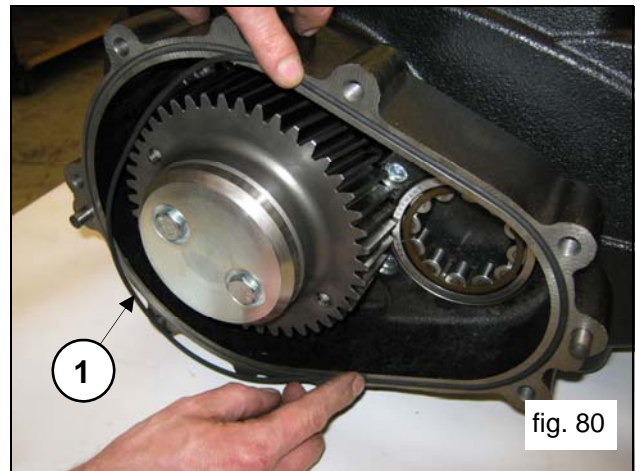
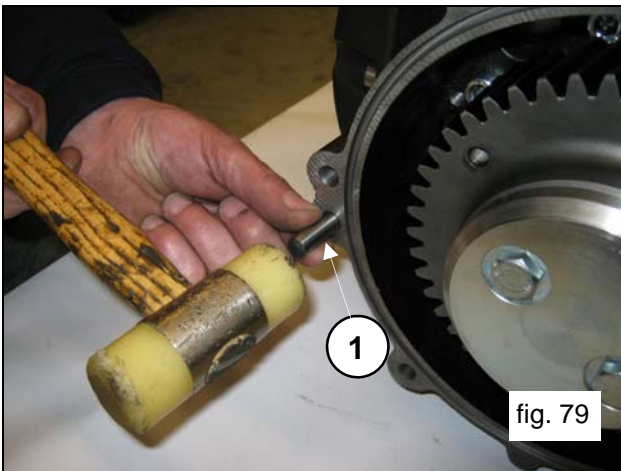

Complete assembly of the pinion on the reduction gear cover, proceeding as follows:
 Pre-assemble the inner bearing ring 40x90x23 on the pinion (pos.①, fig.81) positioning it to end stroke.

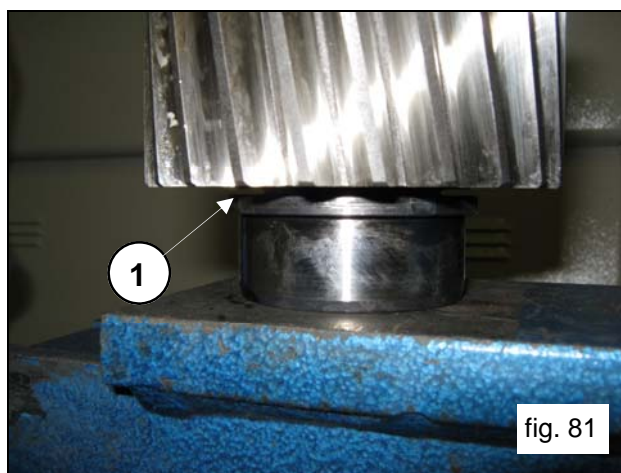

From the other side of the pinion, pre-assemble the bearing 55x120x29 (pos. ①, fig.82) positioning it to end stroke using tool code 27604800 (pos. ①, fig.83).

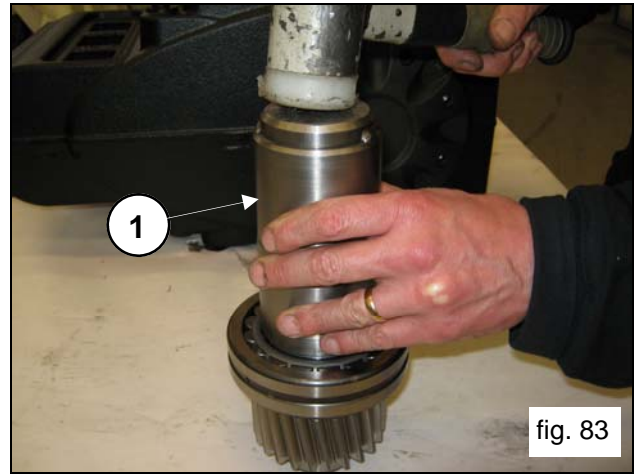
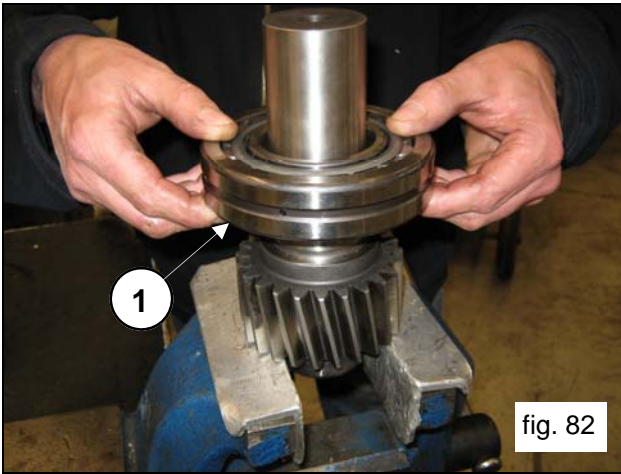

Insert the bearing support ring (pos. ①, fig.84) and position the Seeger ring Ø55 (pos. ①, fig.85)

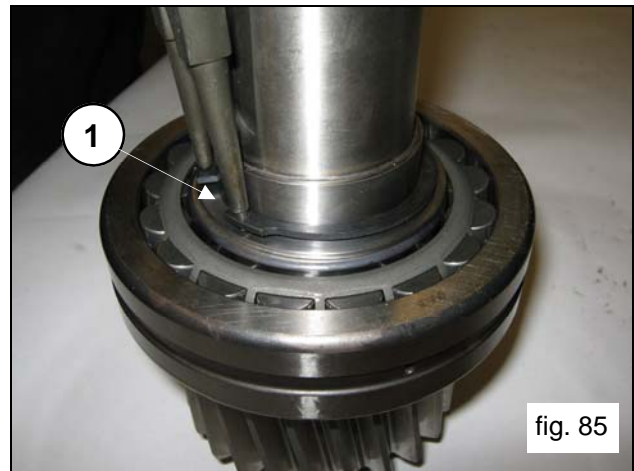
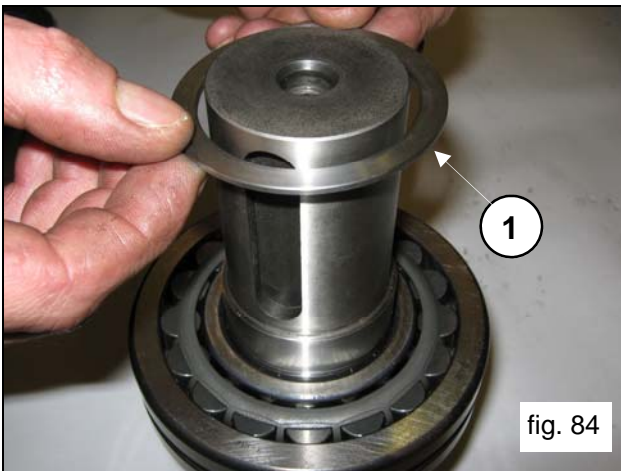

Insert the pinion pre-assembled inside its housing in the reduction gear cover, with the aid of an extractor hammer (pos. ①, fig.86).

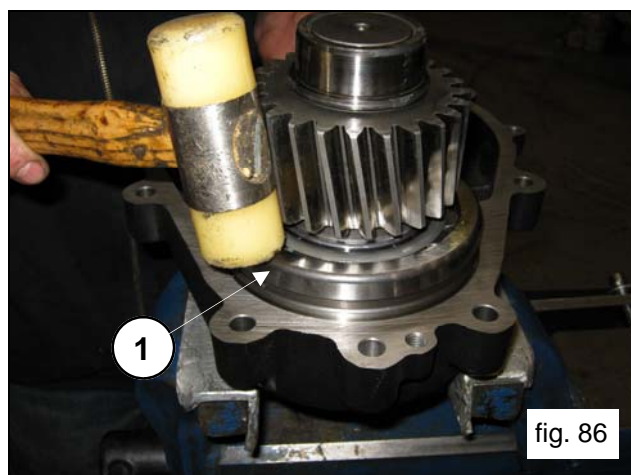

Insert the Seeger ring Ø120 in the housing (pos.①, fig.87)

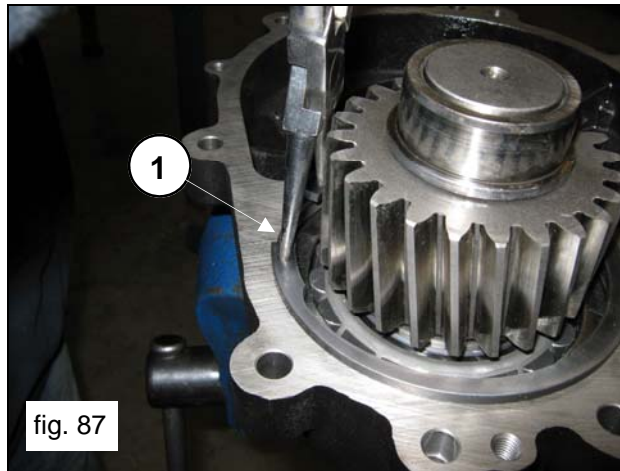

Assemble the reduction gear cover with the aid of an extractor hammer (pos.①, fig.88) and fasten them with 7 M10x40 screws (pos.①, fig.89).

Take care to properly couple the two components on the bearing 40x90x23.

Calibrate the screws with a torque wrench as indicated in paragraph 3 "Screw tightening calibration".

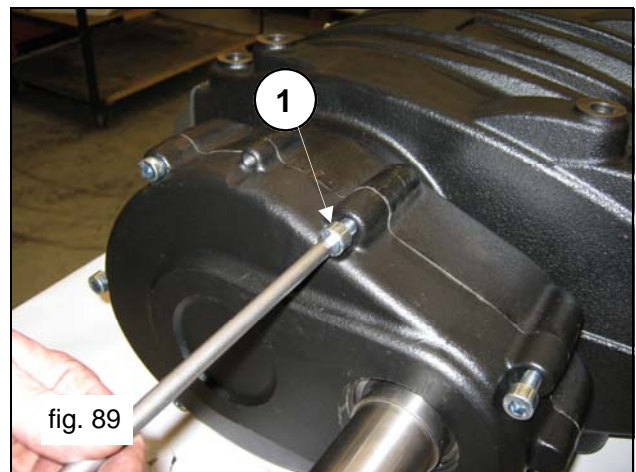
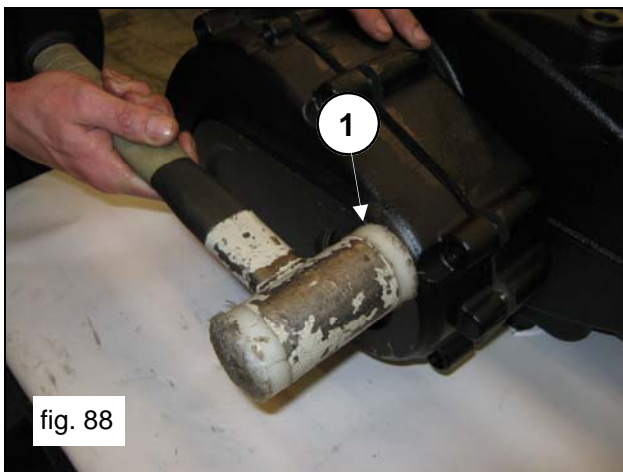

Insert the seal ring inside the reduction gear cover with the use of special tool code 27605200 (pos.①, fig.90).

Before proceeding with seal ring assembly, check lip seal conditions. If replacement is necessary, position the new ring on the bottom of the groove as indicated in fig.91.



If the shaft should present a diameter wear corresponding to the lip seal, to prevent grinding, position the ring in the second stroke as indicated in fig. 91.

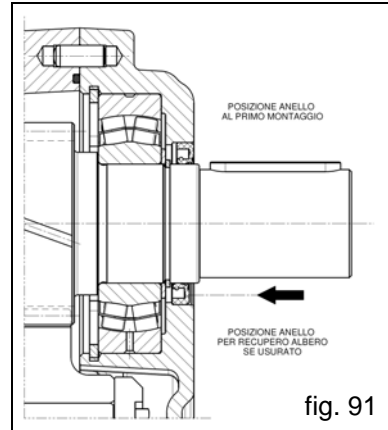

POSIZIONE ANELLO AL PRIMO MONTAGGIO	RING POSITION AT FIRST ASSEMBLY
POSIZIONE ANELLO PER RECUPERO ALBERO SE USURATO	RING POSITION FOR SHAFT RECOVERY IF WORN

⚠ To prevent damage to the seal ring, take special care when inserting the seal ring on the pinion

Apply O-rings on the inspection covers (pos. ①, fig.92) and tighten with 2+2 M6x14 screws (pos. ①, fig.93). Calibrate the screws with a torque wrench as indicated in paragraph 3 "Screw tightening calibration".

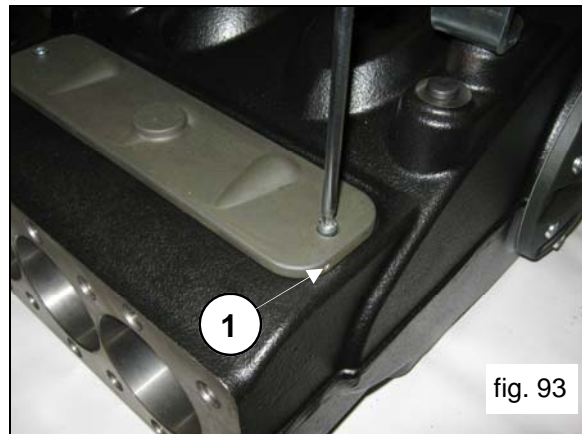
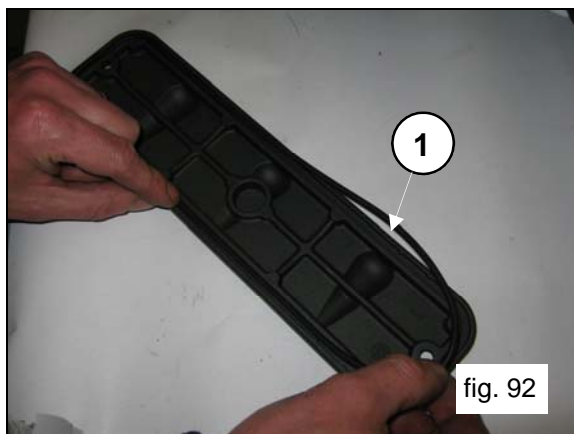

Insert the tab 14x9x60 on the pinion.
Apply plugs and lifting brackets with the use of M16x30 screws (pos. ①, fig.94).
Calibrate the screws with a torque wrench as indicated in paragraph 3 "Screw tightening calibration".

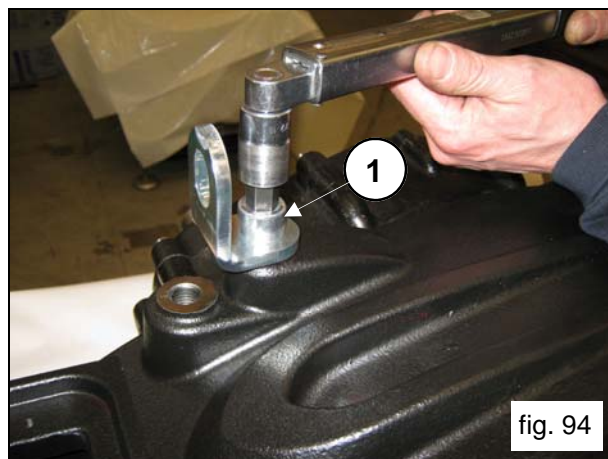

Insert oil in the casing as indicated in the use and maintenance manual point 7.4.

2.1.3 Increase and reduction classes

TABLE OF REDUCTIONS FOR BEND SHAFTS AND CON-ROD HALF-BEARINGS			
Recovery classes (mm)	Code Half-bearing Upper	Code Half-bearing Lower	Correction on the shaft pin diameter (mm)
0.25	90928100	90928400	Ø79.75 0/-0.02 Ra 0.4 Rt 3.5
0.50	90928200	90928500	Ø79.50 0/-0.02 Ra 0.4 Rt 3.5

INCREASE TABLE FOR PUMP CASING AND PISTON GUIDE		
Recovery classes (mm)	Code Piston Guide	Adjustments on the Pump Casing housing (mm)
1.00	73050243	Ø71 H6 +0.019/0 Ra 0.8 Rt 6

2.2 Repairing hydraulic parts

2.2.1 Dismantling the head – liner – valves

The head does not require any routine maintenance.

Operations are limited to inspection or replacement of valves, if necessary.

Proceed as follows to extract valve groups:

Unscrew the M10x140 head liner fixing screws without removing them (pos. ①, fig.95), in such a way as to free them.

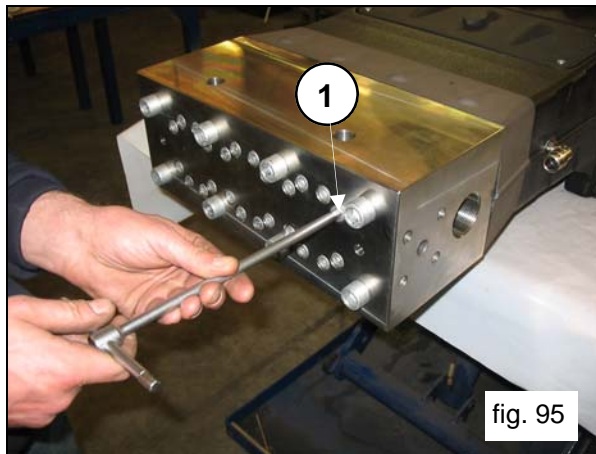

Unscrew the two diametrically opposed M16x320 head fixing screws (pos. ① and ②, fig.96) replace them with two screw-slave pins (cod.27540200) (pos. ①, fig.97), and then removing the remaining screws.

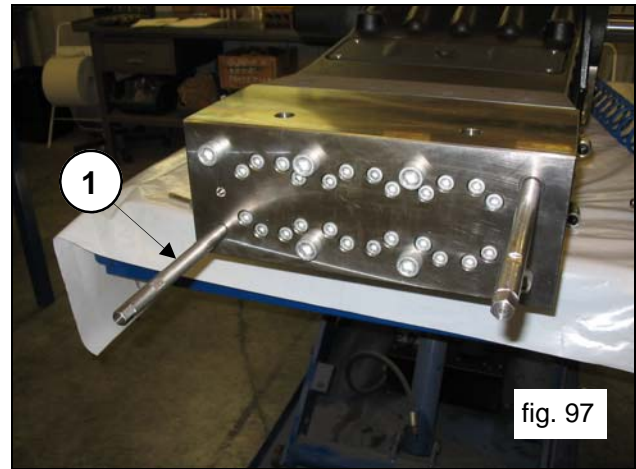
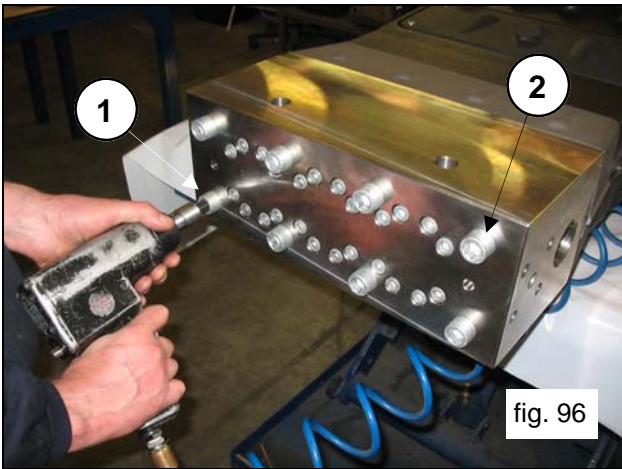

Separate the head and the spacer for the pump casing liners (pos. ①, fig.98).

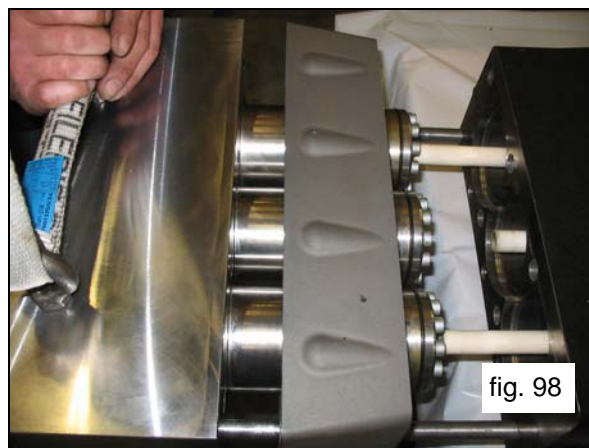

Remove the spacer for pump casing liner from the liner units (pos. ①, fig.99).



Remove the M10x140 head liner fixing screws (pos. ①, fig.100) and remove the liner units (pos. ①, fig.101).

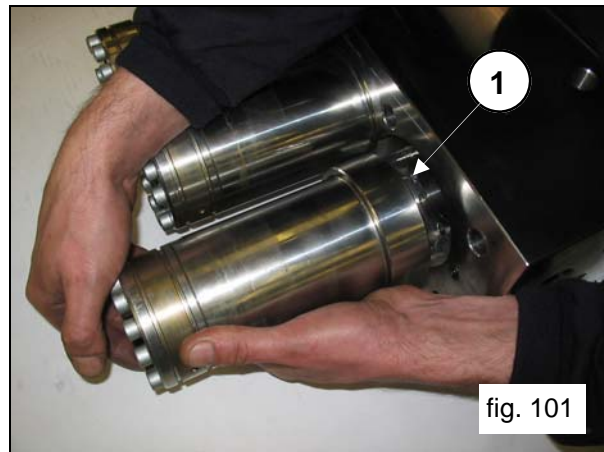
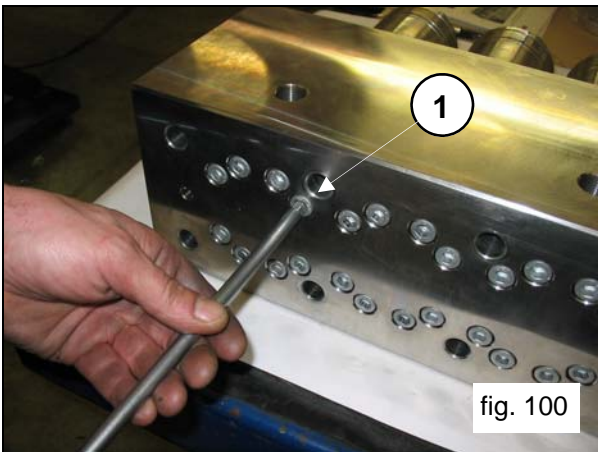

During disassembly of the liners, take care not to disperse the valve springs and the flat valves (pos. ① and ②, fig.102) as, not being locked, they could fall.

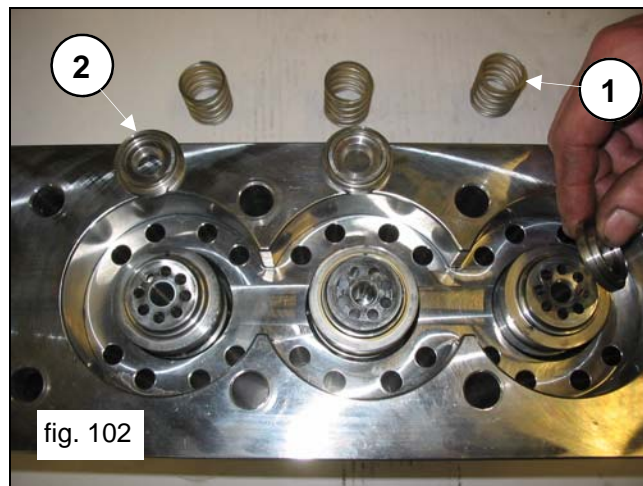

If the valve housings should become blocked on the head due to the forming of limestone or oxide, they must be unblocked by inserting a special tool (code 034300020) in the outlet hole (pos. ①, fig.103).



Extract the valve housings and check the conditions of the various components. If necessary, make any replacements (pos.①, fig.104).

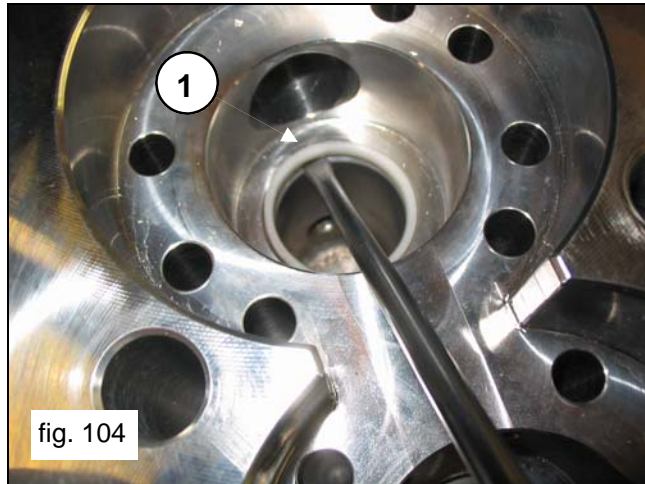

 **At every valve inspection, always replace all seal rings and relative front OR rings between the liner and head, between the head and liner spacer in the recirculation inlet area. Clean and dry components and all relative housings inside the head before replacing.**

Extract the outlet plates (pos.①, fig.105) and their respective guides (pos.①, fig.107) with their springs (pos.①, fig.106). Check their conditions, replace if necessary and at the intervals necessary as indicated in chapter 11 in the use and maintenance manual.

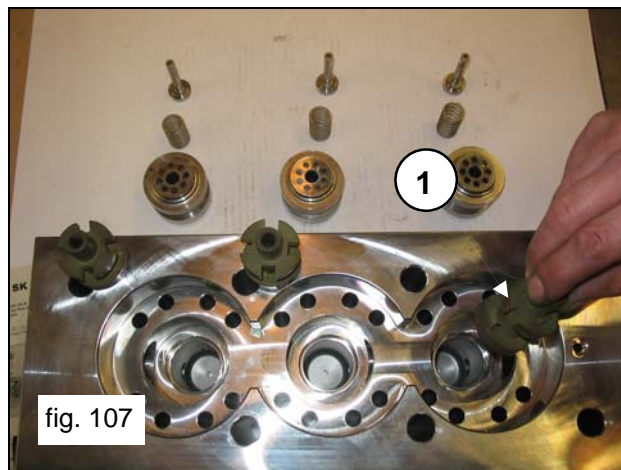
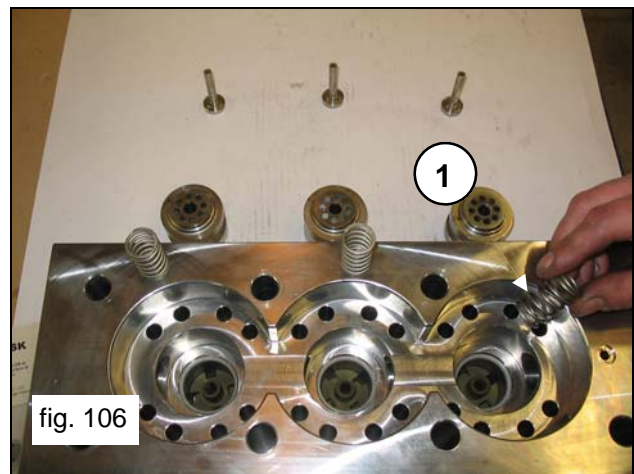
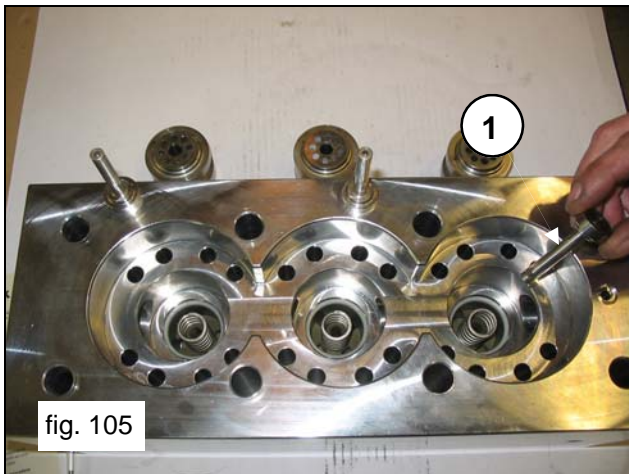

2.2.2 Assembling the head – liner – valves

To reassemble the various components, follow the reverse operations listed above, taking particular care when assembling the liner spacer: the hole Ø6 (seal cooling circuit) must correspond to the same hole for the head (with O-ring).

Heads - liners: proceed with assembly and calibration of the head fixing screws and then with calibration of the liner fixing screws.

For the values of the screw tightening torques and sequences, follow the instructions contained in chapter 3.

2.2.3 Dismantling the piston unit – supports – seals

The piston unit does not require any routine maintenance.

Maintenance is limited to visual inspection of cooling circuit drainage. If abnormalities / variations on the outlet pressure gauge or cooling circuit draining pipe pulsing (if flexible) are detected, the seal pack will have to be checked and replaced.

Proceed as follows to extract piston groups:

Separate the head and the spacer for the pump casing liners as indicated in point 2.2.1. (from fig.95 to fig.101).

Remove the upper inspection cover, unscrewing the 2 fixing screws (pos.①, fig.108).

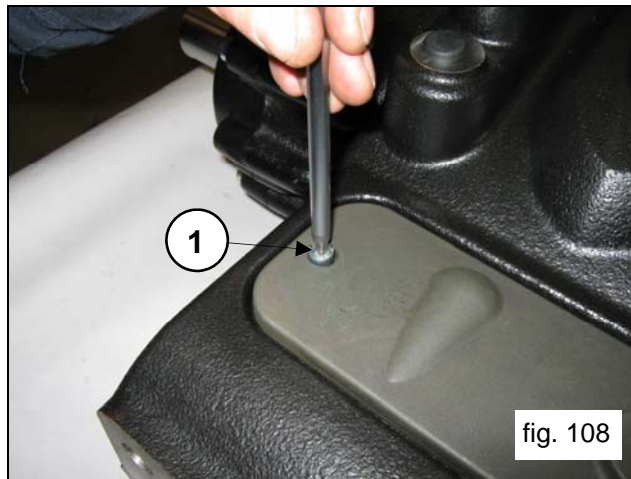

Remove the pumps with a fork spanner (pos.①, fig.109) and check conditions (pos.①, fig.110). Replace if necessary.

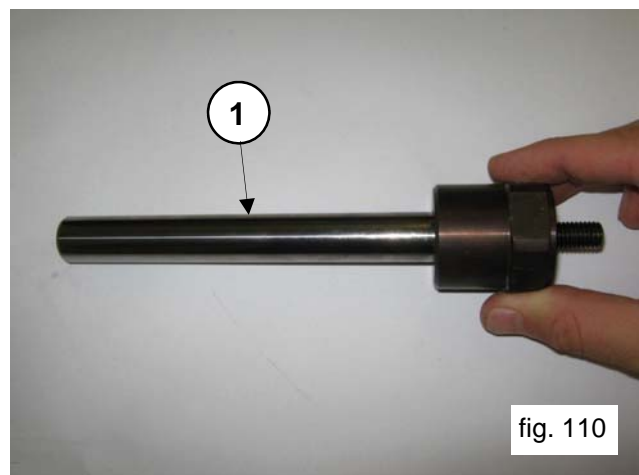
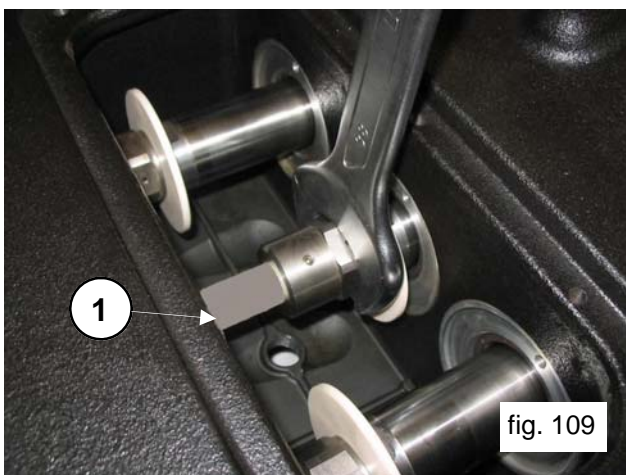

Remove the M8x50 liner support fixing screws (pos.①, fig.111) and separate the support from the liner (pos.①, fig.112).

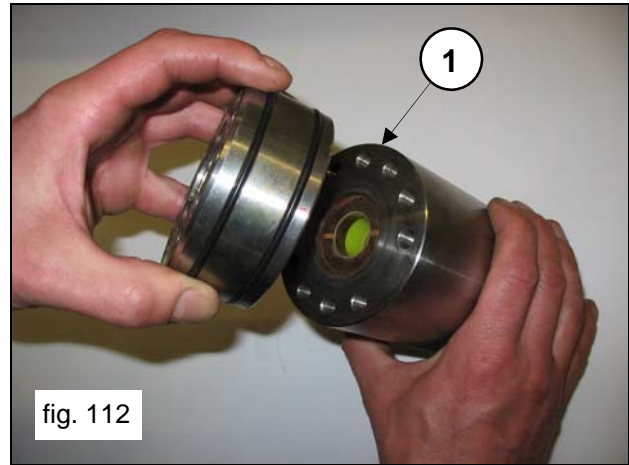
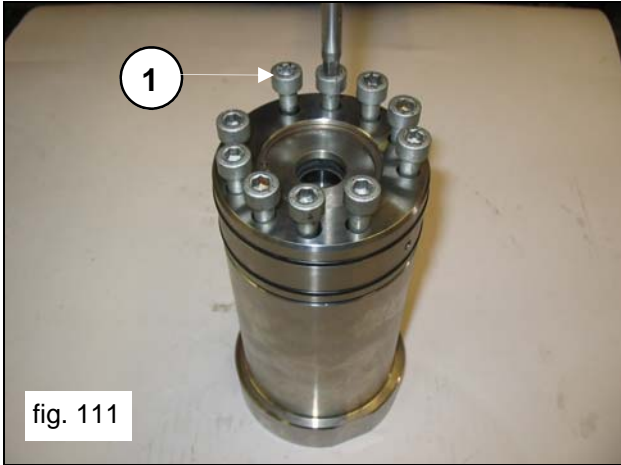

Remove the Seeger ring and the seal ring (pos.①, fig.113) and with a special plastic pin, remove the LP (low pressure) ring seal (pos.①, fig.114).



The OR rings and the low pressure seals must be replaced at each disassembly.

With the liner separate from the seal support and with the special plastic pin (pos.①, fig.115), have the HP (high pressure) pack come out (pos.①, fig.116).



The HP pack (pos.①, fig.116) will have to be replaced at each disassembly.

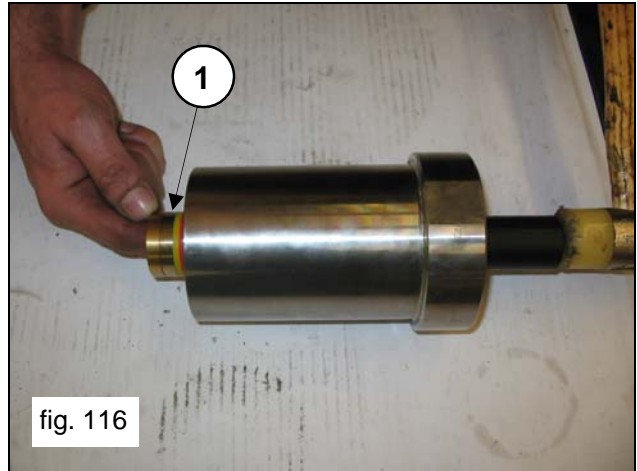
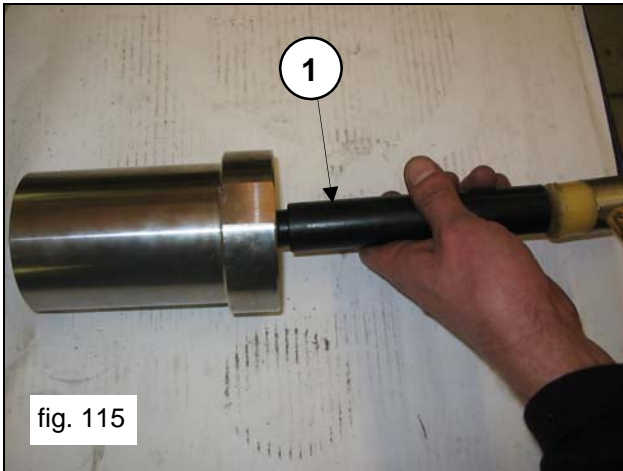

2.2.4 Assembling the piston unit – supports – seals

To reassemble the various components, invert operations paying special attention to the various sequences listed below. For tightening torque values and sequences, follow the instructions contained in chapter 3.

Insert the upper bush in the liner.



For proper axial positioning of the bush, use the special tool (code 27921100 for SM14, code 27921200 for SM16, code 27921300 for SM18, code 27911200 for SM20, code 27911400 for SM22 and code 27911500 for SM24) (pos.①, fig.117 and 118).

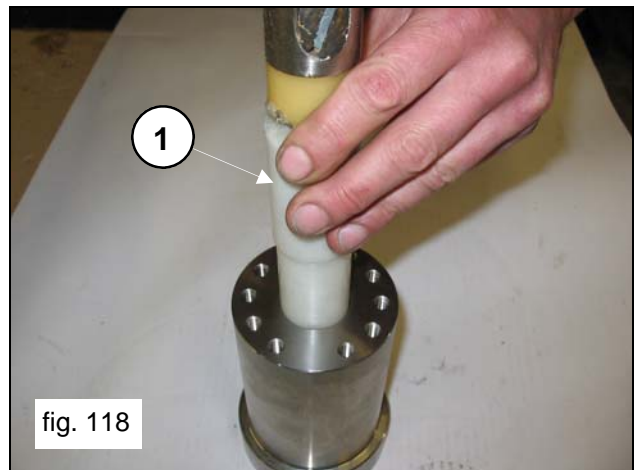
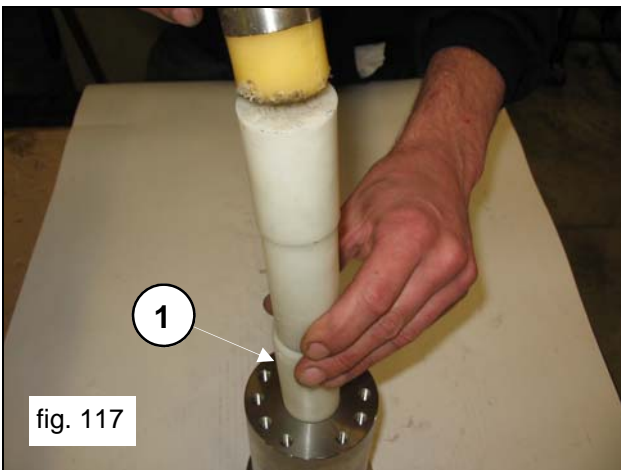

Insert the H.P. pack (high pressure) (pos.①, fig.119). Given the slight interference between the seal and the liner, use a special tool to prevent damage (code 27673200 for SM14, SM16 and SM18, code 27673300 for SM20, for SM22 and for SM24) (pos.①, fig.120).

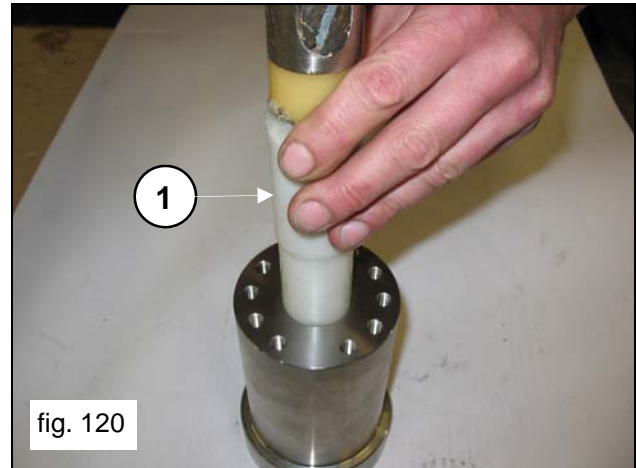
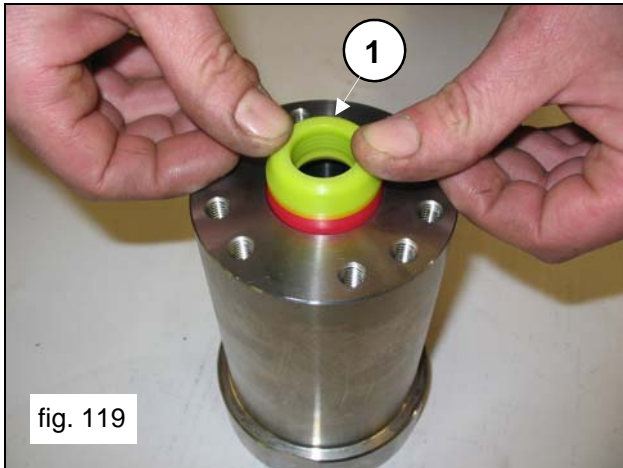

The H.P. seal must be placed in the liner as indicated in fig.121 and 122.



Before mounting the H.P. seals in their housing, they must be lubricated with OKS 1110 silicone grease following the steps below:

The external diameter must be slightly lubricated on the inner diameter, paying special attention to filling all sacs including between the lip seals as indicated in fig. 122.

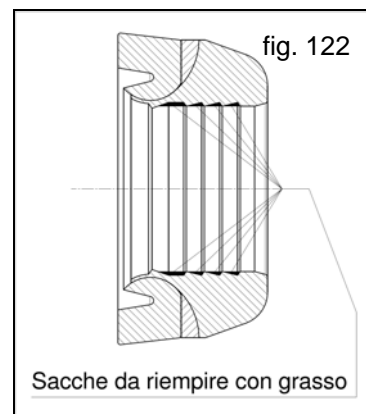

Direzione lavoro pistone	Piston working direction
Sacche da riempire con grasso	Sacs to be filled with grease

Insert the anti-extrusion ring and the seals bush (pos. ① and ②, fig.123 - 124 and 125).



The seal bush ② must be inserted in the liner with the two discharges turned outward (casing side) as indicated in fig.124.

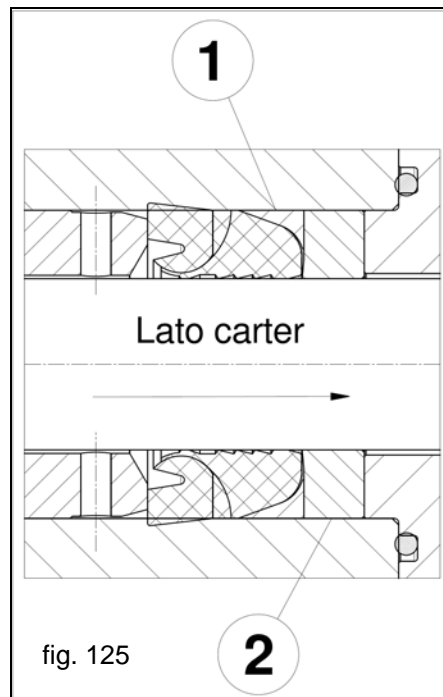
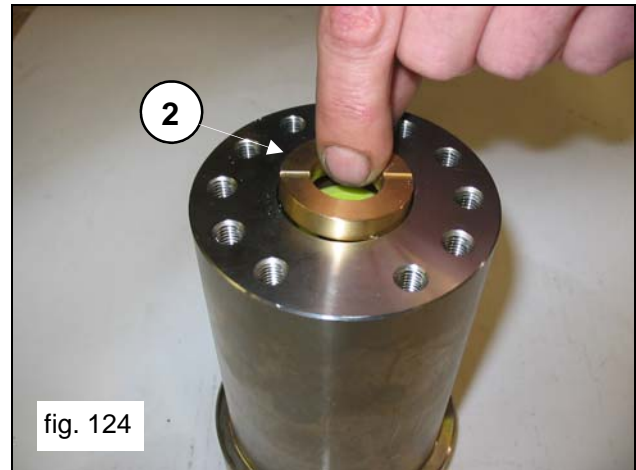

Lato carter | Casing side



The L.P. seal must be inserted in the liner with the lip seal in the direction of piston operation (pos. ①, fig.126 e 127), slightly lubricating the external diameter with OKS 1110 silicone grease. Replace the L.P. seal whenever wear is detected.

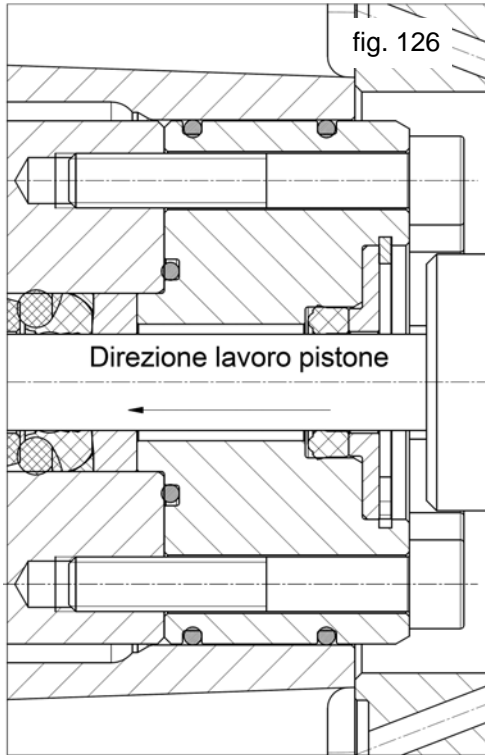

Direzione lavoro pistone	Piston working direction
--------------------------	--------------------------

Replace the seal support unit (fig.128 and 129), replacing components ① and ②.

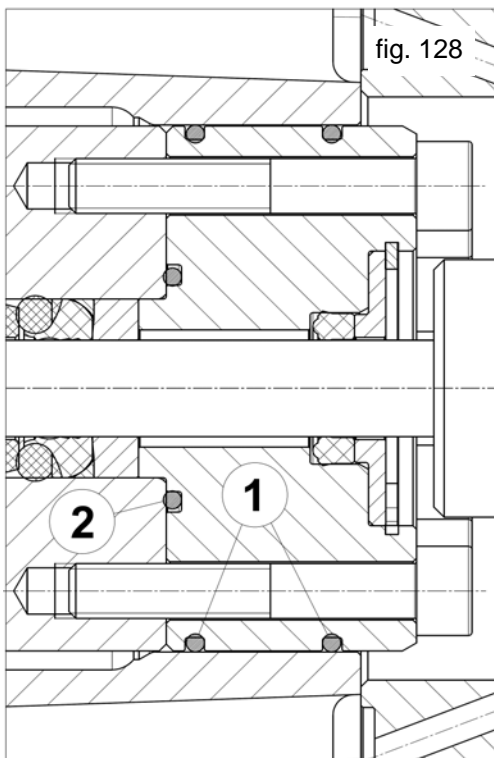

Assemble the support unit - liner, manually screwing in the M8x50 screws as indicated in fig.130, then proceed with calibration with a torque wrench as indicated in chapter 3.

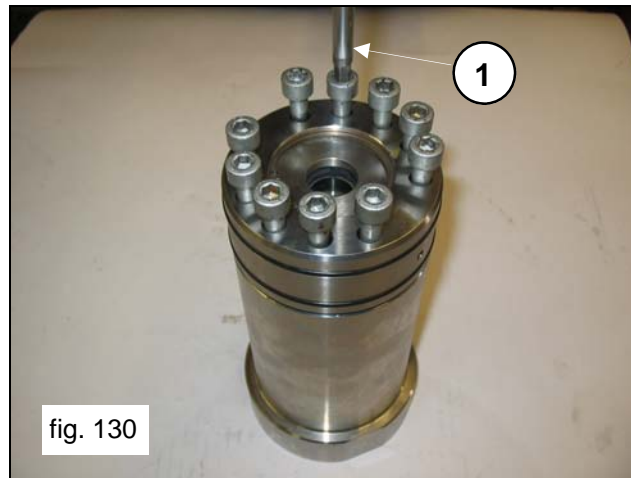

fig. 130

3. SCREW TIGHTENING CALIBRATION

Screw tightening must only be performed with a torque wrench.

Description	Exploded Drawing Position	Tightening Torque Nm
Casing cover M10x30 screw		45
G1/2x13 casing plug		40
Lifting bracket M16x30 screw		200
Reduction gear cover M10x40 screw		45
Ring gear stop M10x25 screw		45
Reduction gear box M10x40 screw		45
Upper and lower cover M6x14 screw		10
Bearing cover M10x30 screw		45
Con-rod fixing M10x1.5x80 screw		65 *
Piston guide M10x35 screw		60
Piston fixing M10x140 screw		40
Complete piston		40
Choke fitting D.3 3/8M-3/8F		45
M8x50 screw supports		40 **
Head M16x280 screw		280 ***
Liner M10x140 screw		83 ****

* Achieve coupling torque tightening screws at the same time



Screws – pos. 1-22-26 must be tightened with a torque wrench, lubricating the threaded shank with Molybdenum Bisulphide grease code 12001500.

** The support fixing screws must be tightened respecting the phases and orders shown in the diagram in fig.131.

*** The head fixing screws must be tightened respecting the phases and orders shown in the diagram in fig.132.

**** The liner fixing screws must be tightened respecting the phases and orders shown in the diagram in fig.132.

Serraggio viti supporto guarnizioni pos.22

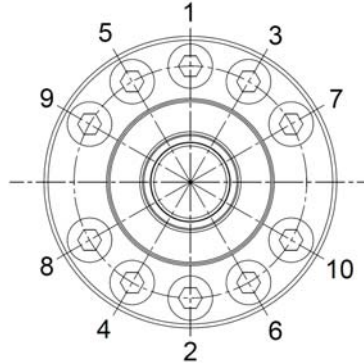

Serraggio viti M8x50 secondo la sequenza indicata
(1-2-3-4-5-6-7-8-9-10) eseguita in un'unica fase alla coppia indicata
fig. 131

Serraggio viti testata e viti camice Pos.1 e Pos.26

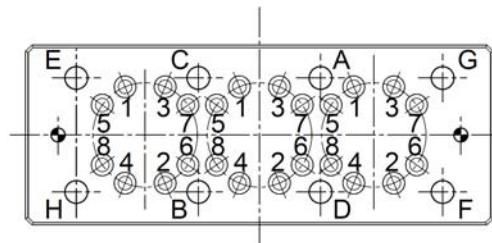

OPERAZIONE 1: Serraggio viti M16x320 (pos.1) in due fasi
rispettando la sequenza indicata in figura : (A-B-C-D-E-F-G-H)

1^ Fase = 200 Nm

2^ Fase = 280 Nm

OPERAZIONE 2: Serraggio viti M10x140 (pos.26) in quattro fasi

rispettando la sequenza indicata in figura : (1-2-3-4-5-6-7-8)

1^ Fase = 40 Nm

2^ Fase = 65 Nm

3^ Fase = 83 Nm

4^ Fase = 83 Nm

fig. 132

<p>Pag.38 Fig.131</p> <p>Serraggio viti supporto guarnizioni pos.22 Serraggio viti M8x50 secondo la sequenza indicata (1-2-3-4-5-6-7-8-9-10) eseguita in un'unica fase alla coppia indicata</p>	<p>Pag.38 Fig.131</p> <p>Gasket support screw tightening pos.22 M8x50 screw tightening according to the indicated sequence (1-2-3-4-5-6-7-8-9-10) performed in a single phase at the indicated torque</p>
<p>Pag.38 Fig.132</p> <p>Serraggio viti testata e viti camice Pos.1 et Pos.26 OPERAZIONE 1 : Serraggio viti M16x320 (pos.1) in due fasi Rispettando la sequenza indicata in figura . (A-B-C-D-E-F-G-H) Fase</p> <p>OPERAZIONE 2 : Serraggio viti M10x140 (pos.26) in quattro fasi Rispettando la sequenza indicata in figura . (1-2-3-4-5-6-7-8) Fase</p>	<p>Pag.38 Fig.132</p> <p>Head screw and liner screw tightening Pos.1 and Pos.26 OPERATION 1 : M16x320 screw tightening (pos.1) in two phases Complying with the sequence indicated in the figure. (A-B-C-D-E-F-G-H) Phase</p> <p>OPERATION 2 : M10x140 screw tightening (pos.26) in four phases Complying with the sequence indicated in the figure. (1-2-3-4-5-6-7-8) Phase</p>

4. REPAIR TOOLS

Pump maintenance can be carried out with simple component disassembly and reassembly tools. The following tools are available:

For assembly:

- Shaft (con-rod interlocking) code 27566200
- Bearing on bend shaft code 27604700
- Pinion bearing on reduction gear box code 27604900
- Bend shaft bearing on the reduction gear box code 27605000
- Bend shaft bearing on the bearing cover code 27605000
- Piston guide oil seal code 27605300
- Bearing on pinion code 27604800
- Pinion seal ring code 27605200
- Piston bush code 27921100 (SM14), code 27921200 (SM16), code 27931300 (SM18)
code 27911200 (SM20), code 27911400 (SM22), code 27911500 (SM24)
- HP seal pack code 27673200 (SM14 – SM16 – SM18)
code 27673300 (SM20 – SM22 – SM24)
- Heads / Liner spacer code 27540200

For disassembly:

- Piston guide oil seal code 27918500
- Shaft (con-rod interlocking) code 27566200
- Valve housing code 034300020
- Heads / Liner spacer code 27540200

5. REPLACING THE CON-ROD FOOT BUSH

Carry out bush fitting at room temperature and perform subsequent processing according to the dimensions and tolerances below fig. 133.

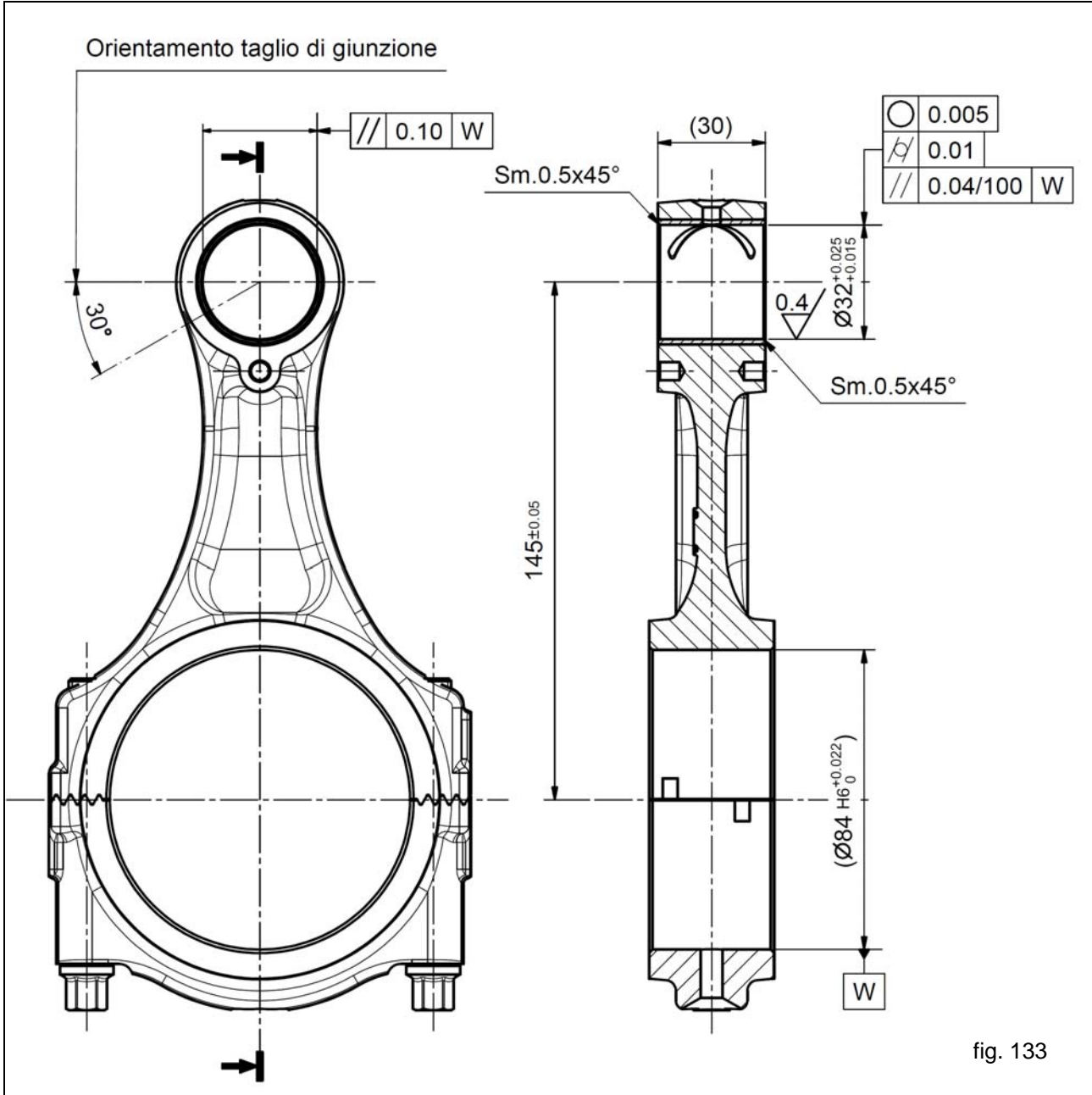

Orientamento taglio di giunzione	Junction cutting direction
----------------------------------	----------------------------

Copyright

Copyright of these operating instructions is property of Interpump Group.
The instructions contain technical descriptions and illustrations which may not be entirely or in part copied nor reproduced electronically nor passed to third parties in any form and in any case without written permission from the owner.

Violators will be prosecuted according to law with appropriate legal action.

Code 73980303 rev.0 - Cod.IE 2860000115 - 27/09/2011
Data contained in this document may change without notice.

PRATISSOLI a brand of INTERPUMP GROUP S.P.A.
42049 S.ILARIO - REGGIO EMILIA (ITALY)
Tel. **+39 - 0522 - 904311** Fax **+39 - 0522 - 904444**
E-mail: info@pratissolipompe.com
<http://www.pratissolipompe.com>

